

GY-DV5000 DV CAMCORDER

JVC[®]

DV CAMCORDER

GY-DV5000
DV Mini DV

INSTRUCTIONS

INTRODUCTION

CONTROLS,
INDICATORS AND
CONNECTORS

BASIC SYSTEM
CONNECTIONS AND
ADJUSTMENTS

POWER SUPPLY

PREPARATIONS

SETTING AND
ADJUSTMENTS
BEFORE SHOOTING

SHOOTING
OPERATION

PLAYBACK MODE

USING EXTERNAL
COMPONENTS

TIME CODE
OPERATION

MENU SCREENS

FEATURES OF THE
CAMERA SECTION

OTHERS



* The illustration shows the GY-DV5000 DV Camcorder with the optional lens, viewfinder, Microphone holder and Microphone attached.

JVC[®]
VICTOR COMPANY OF JAPAN, LIMITED

Thank you for purchasing this JVC product. Before operating this unit, please read the instructions carefully to ensure the best possible performance.

For Customer Use :
Enter below the Serial No. which is located on the body.
Retain this information for future reference.
Model No. GY-DV5000
Serial No. _____

This instruction manual is made from 100% recycled paper.

JVC[®] is a registered trademark owned by VICTOR COMPANY OF JAPAN, LTD.
JVC[®] is a registered trademark in Japan, the U.S.A., the U.K. and many other countries.
© 2002 VICTOR COMPANY OF JAPAN, LIMITED

Printed in Japan
LWT0072-001A

LWT0072-001A

IMPORTANT SAFEGUARDS

1. Read all of these instructions.
2. Save these instructions for later use.
3. All warnings on the product and in the operating instructions should be adhered to.
4. Unplug this appliance system from the wall outlet before cleaning. Do not use liquid cleaners or aerosol cleaners. Use a damp cloth for cleaning.
5. Do not use attachments not recommended by the appliance manufacturer as they may cause hazards.
6. Do not use this appliance near water – for example, near a bathtub, washbowl, kitchen sink, or laundry tub, in a wet basement, or near a swimming pool, etc.
7. Do not place this appliance on an unstable cart, stand, or table. The appliance may fall, causing serious injury to a child or adult, and serious damage to the appliance. Use only with a cart or stand recommended by the manufacturer, or sold with the appliance. Wall or shelf mounting should follow the manufacturer's instructions, and should use a mounting kit approved by the manufacturer. An appliance and cart combination should be moved with care. Quick stops, excessive force, and uneven surfaces may cause the appliance and cart combination to overturn.
8. Slots and openings in the cabinet and the back or bottom are provided for ventilation, and to insure reliable operation of the appliance and to protect it from overheating, these openings must not be blocked or covered. The openings should never be blocked by placing the appliance on a bed, sofa, rug, or other similar surface. This appliance should never be placed near or over a radiator or heat register. This appliance should not be placed in a built-in installation such as a bookcase unless proper ventilation is provided.
9. This appliance should be operated only from the type of power source indicated on the marking label. If you are not sure of the type of power supplied to your home, consult your dealer or local power company. For appliance designed to operate from battery power, refer to the operating instructions.
10. This appliance system is equipped with a 3-wire grounding type plug (a plug having a third (grounding) pin). This plug will only fit into a grounding-type power outlet. This is a safety feature. If you are unable to insert the plug into the outlet, contact your electrician to replace your obsolete outlet. Do not defeat the safety purpose of the grounding plug.
11. For added protection for this product during a lightning storm, or when it is left unattended and unused for long periods of time, unplug it from the wall outlet and disconnect the antenna or cable system. This will prevent damage to the product due to lightning and power-line surges.
12. Do not allow anything to rest on the power cord. Do not locate this appliance where the cord will be abused by persons walking on it.
13. Follow all warnings and instructions marked on the appliance.
14. Do not overload wall outlets and extension cords as this can result in fire or electric shock.
15. Never push objects of any kind into this appliance through cabinet slots as they may touch dangerous voltage points or short out parts that could result in a fire or electric shock. Never spill liquid of any kind on the appliance.
16. Do not attempt to service this appliance yourself as opening or removing covers may expose you to dangerous voltage or other hazards. Refer all servicing to qualified service personnel.
17. Unplug this appliance from the wall outlet and refer servicing to qualified service personnel under the following conditions:
 - a. When the power cord or plug is damaged or frayed.
 - b. If liquid has been spilled into the appliance.
 - c. If the appliance has been exposed to rain or water.
 - d. If the appliance does not operate normally by following the operating instructions. Adjust only those controls that are covered by the operating instructions as improper adjustment of other controls may result in damage and will often require extensive work by a qualified technician to restore the appliance to normal operation.
 - e. If the appliance has been dropped or the cabinet has been damaged.
 - f. When the appliance exhibits a distinct change in performance – this indicates a need for service.
18. When replacement parts are required, be sure the service technician has used replacement parts specified by the manufacturer that have the same characteristics as the original part. Unauthorized substitutions may result in fire, electric shock, or other hazards.
19. Upon completion of any service or repairs to this appliance, ask the service technician to perform routine safety checks to determine that the appliance is in safe operating condition.

PORTABLE CART WARNING
(symbol provided by RETAC)



SAFETY PRECAUTIONS

FOR USA AND CANADA



The lightning flash with arrowhead symbol, within an equilateral triangle is intended to alert the user to the presence of uninsulated "dangerous voltage" within the product's enclosure that may be of sufficient magnitude to constitute a risk of electric shock to persons.



The exclamation point within an equilateral triangle is intended to alert the user to the presence of important operating and maintenance (servicing) instructions in the literature accompanying the appliance.

WARNING:
TO REDUCE THE RISK OF FIRE OR ELECTRIC SHOCK, DO NOT EXPOSE THIS APPLIANCE TO RAIN OR MOISTURE.

This unit should be used with 12V DC only.

CAUTION:
To prevent electric shocks and fire hazards, do NOT use any other power source.

NOTE:

The rating plate (serial number plate) is on the top frame.

CAUTION

To prevent electric shock, do not open the cabinet. No user serviceable parts inside. Refer servicing to qualified service personnel.

AVERTISSEMENT :
POUR EVITER LES RISQUES D'INCENDIE OU D'ELECTROCUTION, NE PAS EXPOSER L'APPAREIL A L'HUMIDITE OU A LA PLUIE.

Ce magnétoscope ne doit être utilisé que sur du courant direct en 12V.

ATTENTION :
Afin d'éviter tout resque d'incendie ou d'électrocution, ne pas utiliser d'autres sources d'alimentation électrique.

REMARQUE :

La plaque d'identification (numéro de série) se trouve sur le panneau arrière de l'appareil.

INFORMATION FOR USA

INFORMATION

This equipment has been tested and found to comply with the limits for a Class B digital device, pursuant to Part 15 of the FCC Rules. These limits are designed to provide reasonable protection against harmful interference in a residential installation. This equipment generates, uses, and can radiate radio frequency energy and, if not installed and used in accordance with the instructions, may cause harmful interference to radio communications. However, there is no guarantee that interference will not occur in a particular installation. If this equipment does cause harmful interference to radio or television reception, which can be determined by turning the equipment off and on, the user is encouraged to try to correct the interference by one or more of the following measures:

- Reorient or relocate the receiving antenna.
- Increase the separation between the equipment and receiver.
- Connect the equipment into an outlet on a circuit different from that to which the receiver is connected.
- Consult the dealer or an experienced radio/TV technician for help.

CAUTION

CHANGES OR MODIFICATIONS NOT APPROVED BY JVC COULD VOID USER'S AUTHORITY TO OPERATE THE EQUIPMENT.

THIS DEVICE COMPLIES WITH PART 15 OF THE FCC RULES. OPERATION IS SUBJECT TO THE FOLLOWING TWO CONDITIONS : (1) THIS DEVICE MAY NOT CAUSE HARMFUL INTERFERENCE, AND (2) THIS DEVICE MUST ACCEPT ANY INTERFERENCE RECEIVED, INCLUDING INTERFERENCE THAT MAY CAUSE UNDESIRED OPERATION

INFORMATION (FOR CANADA) RENSEIGNEMENT (POUR CANADA)

This Class B digital apparatus complies with Canadian ICES-003.

Cet appareil numérique de la Class B est conforme à la norme NMB-003 du Canada.

Thank you for purchasing the DV Camcorder GY-DV5000.
These instructions are for GY-DV5000U.

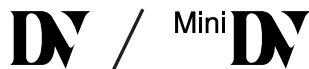

This unit is a DV video system format camcorder. Videocassettes marked with the DV symbol or "Mini DV" symbol can be used.

The following phenomena may occur when tapes recorded on other units (including another GY-DV5000) are recorded or played back on this camcorder.

- The transient section between scenes recorded on other units and those recorded on this unit may appear disturbed.
- Digital noise may appear during playback due to tracking errors.

MAIN FEATURES

- Built-in compatible mechanism for use of both standard-size DV videocassettes and mini-size DV videocassettes. Recording/playback can be made to/from Standard DV, Mini DV and DVCAM cassettes in DV format. Tapes recorded in the DVCAM format can only be played back (simple playback). Recording in the DVCAM format is not possible. DVCAM is a registered trademark of SONY Corporation.
- Compact, lightweight design. Employment of aluminum die cast has resulted in an operation-condition weight as low as approximately 5.5 kg including lens, viewfinder, battery, and cassette.
- DV high-quality digital format. The 4:1:1, 8-bit, 25 Mbps component digital processing ensures recording and playback with high picture quality.
- High sound quality based on PCM audio. Two types of sampling, 16-bit, 48 kHz sampling and 12-bit, 32 kHz sampling, ensure high-quality digital audio.
- Time code reader/generator. The built-in time code reader/generator can be used to record SMPTE time code and user's bits.
- Built-in 2.5" color LCD display. In addition to displaying the camera image and the playback image, the LCD monitor shows the status screens, menu screens for settings, and alarm indications.
- Built-in monitor loudspeaker for audio checking. The input audio can be monitored in recording or EE mode. The playback sound can be monitored in the playback mode. The loudspeaker also outputs an alarm tone in case an abnormal condition occurs in the unit.
- Recording check function for convenient recording review and edit search function.
- Camera section designed with 3-CCD system for high-quality picture. 1/2" 3-CCD with 380,000 effective pixels employed. Digital signal processing for reproduction of DV high-quality picture.
- Super sensitivity F13, 2000 lux. 2000 lux standard sensitivity increased to F13 while high S/N is retained. Enables shooting at normal indoor illumination eliminating the need for extra illumination.
- LOLUX for 0.2 lux (F1.4) illumination. Employment of LOLUX mode ensures +36 dB gain. This is ideal for difficult shooting conditions with almost no illumination. The gain up value can be selected in the menu.
- Multi-Zone Auto Iris Detection Circuit. Multi-zone auto iris detection circuit ensures optimum iris position even in backlit conditions or when a bright subject moves in a frame. Switch provided for selecting over or under level.
- Safety Zone indication in viewfinder. Two types of safety zone indicator functions provided.
- Zebra pattern video level indication in viewfinder.
- Full Auto Shooting (FAS) function. Eliminating the need for troublesome switch or filter operations, the FAS function automatically provides a wide range of compatibility with shooting conditions which varies as you move between indoors and outdoors or between bright and dark locations.
- Color temperature conversion filters for 3200K, 5600K, 5600K + 1/8ND, 5600 + 1/64ND provided.
- Variable scan shutter. Eliminates flicker when shooting other screen pictures than NTSC, such as computer monitor screens. Copes with the range from 60.1 Hz to 2084.6 Hz.
- DV (i. LINK) connector. DV connector (4-pin) provided. Enables transfer of digital data to other equipment provided with DV connector, such as a non-linear editing system.
- 1/2" bayonet type lens.
- Camera output, VCR playback output (composite/YC) possible.
- Built-in color bar (SMPTE type).
- Superior operability with shutter speed and menus selected by dial.
- Connection to network possible (when the optional Network Pack KA-DV5000 is attached). Video and audio streaming data can be transmitted through a LAN card and recorded on memory cards.

- This unit records and plays back in the SP mode. Recording or playback in the LP mode is not possible.
- Due to manufacturing dispersion of tapes, we recommend not to record pictures within the first 2 to 3 minutes from the beginning of the tape.
- Before recording important scenes, be sure to perform a test recording and confirm that both video and audio are recorded correctly.
- Recorded video and audio contents are for private use. Other use may infringe on the rights of copyright holders.
- JVC cannot assume liabilities that may derive from the impossibility of normal recording or playback of video or audio due to malfunction of the camcorder or the videocassette.

CONTENTS

INTRODUCTION

MAIN FEATURES	4
1. INTRODUCTION	
1-1 Precautions for Proper Use	6
1-2 Routine and Periodical Maintenance	7
1-3 Precautions for Use of Head Cleaning Tape	8
1-4 Videocassette to be Used	8
1-5 Battery Pack to be Used	8
1-6 Condensation	9
1-7 Characteristic CCD Phenomena	9

2. CONTROLS, INDICATORS AND CONNECTORS	
2-1 Front Section	10
2-2 Right Side Section	12
2-3 Left Side Section	16
2-4 Top Section	17
2-5 Rear Section	18
2-6 Indications on the LCD Monitor and in the Viewfinder	20
2-7 Lens (Optional)	27
2-8 1.5-Inch Viewfinder (Optional)	28

PREPARATIONS

3. BASIC SYSTEM CONNECTIONS AND ADJUSTMENTS	
3-1 Basic System	29
3-2 Attaching the Zoom Lens	30
3-3 Attaching the Viewfinder	30
3-4 Attaching the Microphone (Provided)	31
3-5 Attaching the Microphone (Optional)	31
3-6 Attaching the Tripod Base (Provided)	32

4. POWER SUPPLY	
4-1 AC Operation	33
4-2 Battery Pack Operation (Optional)	33

BASIC OPERATIONS

5. PREPARATIONS	
5-1 Turning the Power ON	37
5-2 Cassette Loading and Unloading	38
5-3 Viewing the LCD Monitor	40
5-4 Setting, Displaying and Recording the Date and Time	41
5-5 Charging the Built-in Battery	44

6. SETTING AND ADJUSTMENTS BEFORE SHOOTING	
6-1 Camera Settings	45
6-2 Screen Size (4:3/LETTER) Mode Selection	45
6-3 Viewfinder Adjustment	46
6-4 External Monitor Adjustment	46
6-5 Back Focus Adjustment	47
6-6 White Balance Adjustment	48
6-7 Audio Input Signal Selection	49
6-8 Recording Level Adjustment	50
6-9 Monitoring Audio during Recording	51

7. SHOOTING OPERATION	
7-1 Basic Recording Operation	52
7-2 Searching for Recorded Scenes (Edit Search)	54
7-3 If the Record-Standby Mode Continues	55
7-4 Checking Recorded Contents in Record-Standby Mode (Recording Check Function)	55
7-5 Recording the Color Bars	56

8. PLAYBACK MODE	
8-1 Playback Procedure	57
8-2 Fast-Forward, Rewind	58
8-3 Search	58
8-4 Blank Search	58
8-5 Outputting CH-3, CH-4 Channel Audio	59

APPLICATION

9. USING EXTERNAL COMPONENTS	
9-1 Connecting a Video Component with DV Connector	60

10. TIME CODE OPERATION	
10-1 Displaying Time Code	62
10-2 Presetting and Recording of Time Code	62
10-3 Recording Time Codes in Continuation of Time Codes Recorded on Tape	64
10-4 Reproducing Time Codes	64

11. MENU SCREENS	
11-1 Menu Screen Configuration	65
11-2 Setting Menu Screens	66
11-3 FILE MANAGE Menu Screen	67
11-4 TOP MENU Screen	68
11-5 CAMERA OPERATION Menu Screen	69
11-6 CAMERA PROCESS MENU Screen	70
11-7 ADVANCED PROCESS Screen	71
11-8 SKIN COLOR ADJUST Screen	71
11-9 AUDIO/VIDEO Menu Screen	72
11-10 LCD/VF Menu Screen	73
11-11 TC/UB/CLOCK Menu Screen	75
11-12 TIME/DATE Menu Screen	76
11-13 OTHERS Menu Screen	77

12. FEATURES OF THE CAMERA SECTION	
12-1 Full-Time Auto White Balance (FAW)	79
12-2 IRIS (Brightness) Adjustment	80
12-3 Adjusting the Shutter Speed	81
12-4 Shooting the Screen Image on a Computer Monitor	82
12-5 Gain (Sensitivity) Adjustment	83
12-6 Switch Setup According to Illumination and Subject	84
12-7 How to Use Skin Detail	85

OTHERS

13. OTHERS	
13-1 Alarm Indications and Actions	87
13-2 Troubleshooting	90
13-3 Hour Meter Display	91
13-4 Specifications	92

1. INTRODUCTION

1-1 Precautions for Proper Use

- Supply voltage**
 Make sure that the power is between 11 V and 15 V DC. If the power voltage is too low, abnormal color and increased noise may occur. Do not exceed 15 V DC in any case, or the unit could be damaged.
- Allowable ambient temperature and humidity**
 Be sure to use the unit within the allowable temperature range of 0°C to 40°C and a relative humidity of 30% to 80%. Using the unit at a temperature or humidity outside the allowable ranges could result not only in malfunction but the impact on the CCD elements could be serious as small white spots may be generated. When storing the GY-DV5000 for a long time, the storage temperatures should be -20°C to 60°C.
- Strong electromagnetic waves or magnetism**
 Noise may appear in the picture or audio and/or the colors may be incorrect if the camera is used near a radio or television transmitting antenna, in places where strong magnetic fields are generated by transformers, motors, etc., or near devices emitting radio waves, such as transceivers or cellular phones.
- Use of wireless microphone near the camera**
 When a wireless microphone or wireless microphone tuner is used near the camera during recording, the tuner could pick up noise.
- Avoid using or placing the unit in places;
 - subject to extreme heat or cold;
 - with excessive dirt or dust;
 - with high humidity or moisture;
 - subject to smoke or vapour such as near a cooking stove;
 - subject to strong vibrations or on an unstable surface.
 • also do not leave the unit for long hours in a parked car under direct sunlight or near room heating equipment.
- Do not leave the unit where it is subject to radiation or x-rays or where corrosive gasses occur.**
- Protect the unit from being splashed with water**
 (especially when shooting in the rain).
- Protect the unit from being wet when shooting on a beach. In addition, salt and sand may adhere to the camera body. Be sure to clean the camera after use.
- Protect the unit against penetration of dust when using it in a place subject to sandy dust.
- Setup level**
 The video signal of the unit's video output is provided with a setup level when shipped from the factory. If you want to turn OFF the setup level, set the SET UP item on the AUDIO/VIDEO menu screen to 0.0%.
- Optical performance of lens**
 Due to the optical performance of the lens, color divergence phenomena (magnification chromatic aberration) may occur at the periphery of the image. This is not a camera malfunction.
- Noise may appear in the viewfinder when switching between the playback picture and the EE picture.
- Use the unit in an upright position.**
 If placed on its side, heat release efficiency will deteriorate, adversely affecting the tape transport. Depending on circumstances the tape may also be damaged.
- Vibrations**
 Colors may fail to appear and/or the image and sound may be disturbed during VTR playback in locations subjected to strong vibrations.

- Precautions for transportation**
 Do not drop or hit the unit against a hard object.
- Remove the videocassette before transporting the unit.
- Do not insert an object other than a videocassette in the cassette insertion slot. Be sure to close the cassette cover when the unit is not to be used for a long period.
- Do not set the POWER switch to OFF or remove the power cable during recording or playback. Otherwise the tape may be damaged.
- The sensitivity level of the provided microphone is set lower than the reference input (-60 dBs) setting.
- When the unit is not in use, be sure to set the POWER switch to OFF in order to reduce power consumption.
- Cleaning the body: Wipe body with a dry, soft cloth. When it is extremely dirty, soak the cloth in a solution of neutral detergent, wipe the body with it, and then use a clean cloth to remove the detergent. To prevent deformation of the body, etc. and to avoid operation hazards, do not allow volatile liquids such as benzene and thinner to touch the body, and do not wipe it with a cloth soaked in such a liquid.
- The camera may not show stable pictures in the period immediately after the power is turned on, but this is not a malfunction.
- If a tape containing recorded PAL signals is played back, "PAL INHIBIT" is displayed and correct playback will not take place. If this happens, remove the videocassette so that the unit returns to its normal state.
- When turning on the power with the tape inserted or after loading a tape, the built-in head cleaner will emit a sound while operating. However, this is not a malfunction of the unit.
- The LCD screen and the viewfinder screen are manufactured using high-precision technology. Black spots may appear on the LCD screen and the viewfinder screen, or red, blue, green and/or white spots may not turn off. However, this is not a malfunction and these spots are not recorded on the tape.
- Do not insert fingers or foreign objects into the cassette insertion slot as this may result in personal injury or damage to the mechanism.

CAUTION :

- Do not point the lens or viewfinder directly at the sun or other strong light source.
 - Eye damage could result.
 - If the lens or viewfinder is left pointed at the sun, rays may collect inside the unit and cause damage or a fire.
- When carrying the camera, be sure to hold the carrying handle. Holding the lens or viewfinder may result in damage.

1. INTRODUCTION

1-2 Routine and Periodical Maintenance

The GY-DV5000 incorporates precision mechanical parts, which will collect dirt, wear out and deteriorate as the unit is used. After the unit has been used for a long period even in a normal environment, the heads, drums and tape transport mechanisms also collect dirt. Especially, dust which penetrates the inside of the VCR section during outdoor use will promote the wear and deterioration of mechanical parts by causing poor contact between tape and heads or failing to maintain the video and audio quality at high levels. To prevent wear and deterioration, clean the mechanical parts using a head cleaning tape as routine maintenance. However, cleaning with a head cleaning tape alone is not enough for cleaning the entire tape transport mechanism, so it is also recommended to apply periodical maintenance (inspection) to prevent the sudden occurrence of failure. As the replacement, adjustment and servicing of parts require advanced skill and equipment, please consult the person in charge of professional video equipment at your nearest JVC-authorized service agent.

Head Cleaning

- To maintain beautiful pictures and sound, be sure to use a head cleaning tape to clean the head periodically. (Read the "Precautions for Use of Head Cleaning Tape" on page 8.) If head cleaning is not performed periodically, a type of mosaic noise called block noise may appear in the picture or sound may be interrupted.



Block Noise

- Please use cleaning tape produced by JVC. Do not use head cleaning tapes other than specified. Read the precautions and instructions for use of the head cleaning tape on page 8.
- When dust adheres to the heads, the warning message "HEAD CLEANING REQUIRED!" is displayed on the LCD monitor and in the viewfinder during playback, edit search, and recording check using the RET button on the lens section.



Periodical Maintenance

Contents : Check or replace the following mechanical parts according to the running time.

Running Time	500H	1000 H	1500H	2000H	4000H
Drum ass'y (including heads)	○	○	○	●	●
Head cleaner	☆	●	☆	●	●
Tape guides & rollers	○	☆	☆	●	●
Rotary encoder	-	-	-	☆	●
Gears	-	☆	-	●	●
Drive parts	-	-	-	☆	●

- : Check
- : Clean, check and adjust.
- ☆: Clean and check. Replace as required.
- : Replace.

- The maintenance contents vary depending on the operating environment and method. Therefore, the above data should be considered as a reference.

Time management

The accumulated running time of the unit can be confirmed with the hour meter display (which shows the accumulated drum running time). For details, see "HOUR METER DISPLAY" on page 91.

For consultations related to the maintenance planning or cost, please contact the person in charge of professional video equipment at your nearest JVC-authorized service agent.

1. INTRODUCTION

1-3 Precautions for Use of Head Cleaning Tape

Please use cleaning tape produced by JVC. Adhere to the following precautions when using the head cleaning tape.

1. Place the unit in the STOP mode.
2. The tape runs for 10 seconds at a time in the PLAY mode. (The tape stops automatically and then the unit enters the SAVE MODE.) Press the PLAY button after the cleaning tape is fully loaded.
3. Do not use the tape more than four times at the most for each cleaning.
4. The cleaning tape can be used approximately 100 times.

■ Use the following chart as a guide for periodical head cleaning.

Operating environment	Low temperature 0°C to 10°C	Room temperature 10°C to 35°C	High temperature 35°C to 40°C
Yardstick for use of cleaning tape	1 to 2 times every 5 hours	1 to 2 times every 20 to 30 hours	1 to 2 times every 5 hours

- Note 1) When used in a low humidity environment, head cleaning should be conducted at intervals half of those given in the below chart.
- Note 2) If an ME80 tape is used immediately after head cleaning, the "HEAD CLEANING REQUIRED!" indicator may remain on. In this case, let the tape run as the indicator will turn off after the tape has run for a while.
- Note 3) Use the cleaning tape in the room temperature (10°C to 35°C).
- Note 4) The cleaning tape case contains instructions for use of the cleaning tape. However, some of these instructions differ from the contents of this sheet. When using the cleaning tape, please follow the instructions of this sheet.
- Note 5) If the "HEAD CLEANING REQUIRED!" does not disappear after repeated head cleanings, the recording tape may be abnormal. Avoid excessive repeated use of the head cleaning tape.

1-4 Videocassette to be Used

- Use JVC's videocassette tapes marked with the "DV" or "Hi8" symbol.
- **Standard DV videocassette:** LA-DV276, LA-DV186, LA-DV124
- **Mini DV videocassette:** M-DV63PRO, M-DV60, M-DV30
- **Do not use M-DV80.**
- Videocassettes cannot be used upside down.
- Avoid storing a videocassette with its tape not being completely wound, as this may damage the tape. Rewind it to the beginning before placing a cassette into storage.
- Store videocassettes in a place with little humidity and good ventilation where mould does not form.
- **After a videocassette tape has been used repeatedly, it becomes unable to maintain full performance due to an increase in noise caused by dropouts, etc. Do not continue to use a dirty or damaged tape, as this will**

reduce the rotary head life.

- **Videocassette tapes with the "DV" or "Hi8" symbol are provided with a switch on the back to prevent accidental erasure.**
- Slide the switch to SAVE to protect the required recording in the tape from being overwritten.
- To record on the tape, slide the switch to REC.

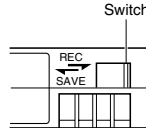

1-5 Battery Pack to be Used

The GY-DV5000 can use any of the following battery packs.

- Flat shape type
- Anton-Bauer battery pack: Trimpack 13.14 Series
Magnum 13.14 Series
Compac 13.14 Series
Propack 13.14 Series

- An Anton-Bauer battery pack cannot be connected directly to the camera. It is necessary to mount the optional battery holder.
 - **Battery holder:** Anton-Bauer QRQ27
- For details on how to mount the battery holder, see page 35.

To display the remaining battery power accurately, set the BATTERY TYPE item on the OTHERS (2/2) menu screen according to the type of the battery pack in use. (See page 78)

1. INTRODUCTION

1-6 Condensation

- If the unit has been cooled down in a cold place and is then carried to a warm place, the moisture contained in the warm air may adhere to the head drum or tape guides and be cooled into water droplets. This phenomenon is referred to as condensation (dewing). When this occurs, the head drum and tape guides are covered with droplets allowing the tape to be stuck to them, leading to tape damage.
- Condensation occurs in the following cases:
 - When the unit is suddenly moved from a cold place to a warm place.
 - When a room heater has just started or when the unit is exposed directly to cold air from an air conditioner.
 - When the unit is placed in a very humid place.

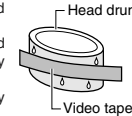

Do not leave the videocassette inserted when moving the camera under conditions where the temperature environment changes. After moving the unit, do not use until the internal parts have stabilized.

- "CONDENSATION ON DRUM" is displayed on the LCD monitor and in the viewfinder when condensation occurs in this unit.

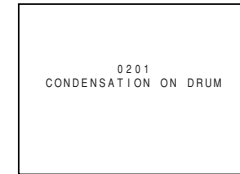

- Keep the power on until the warning message disappears.
 - Pay attention to condensation even before the condensation indication appears.
 - As condensation forms gradually, the condensation indication may not appear for the first 10-15 minutes after condensation has formed inside.
 - In an extremely cold place, the condensation could freeze and turn into frost. In such a case, it takes an additional 2-3 hours for the frost to first melt into condensation and then to be dissolved.
 - To prevent condensation when moving the unit from one place to another where the temperatures are greatly different, first remove the videocassette, place the unit in a tightly sealed vinyl bag, and then move it to a new environment.
- To ensure no condensation occurs, allow the temperature of the unit in the bag to reach that of the new environment before using it.

1-7 Characteristic CCD Phenomena

Smear and Blooming

Due to the physical structure of a CCD it is possible to induce vertical streaking (called "smear") when shooting an extremely bright light source. Another effect is the expansion of light around a bright light or object (called "blooming"). The CCD employed in this unit is characterized by inducing very little smear or blooming. Nevertheless, please take note that smear or blooming may be induced when shooting a bright light source.

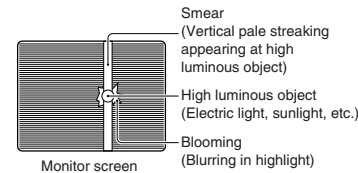

Moire or Aliasing

Shooting stripes or fine patterns may cause a jagged effect or a banding in fine mesh patterns.

White dots

High temperatures can cause CCD sensor pixels to produce the effect of white dots in the image. This condition is conspicuous especially when gain is applied. This is a characteristic of the charged-coupled device (CCD). As far as possible, use the unit under conditions where the temperature of the unit does not increase.

2. CONTROLS, INDICATORS AND CONNECTORS

2-1 Front Section

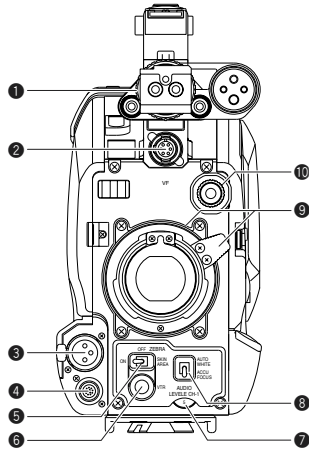

- 1 [Viewfinder mount base, sliding securing ring]**
Mount the viewfinder on the base and secure it using the sliding securing ring.
☞ See "Attaching the Viewfinder" on page 30.
- 2 [VF] Viewfinder connector (6-pin)**
Connect the cable from the viewfinder here.
- 3 [FRONT AUDIO IN] Front audio input connector (XLR 3-pin)**
Balanced 3-pin connector for camera microphone or external audio component.
• Set the FRONT/REAR AUDIO INPUT switch **1** on page 15 in accordance with the connected device.
• To record the audio from this connector, set the CH-1/CH-2 AUDIO INPUT switch **10** on page 15 to "FRONT".
☞ See page 15.

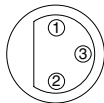

Pin No.	Function
1	GND
2	HOT
3	COLD

CAUTION:

The provided microphone is a phantom microphone. Please confirm that the FRONT AUDIO INPUT switch is set to the +48V side when the provided microphone should be used. When using a microphone other than a phantom microphone, first set the FRONT AUDIO INPUT switch to "LINE" or "MIC" before connecting the microphone.

4 [LENS] Lens control connector

Connect 12-pin lens control cable from lens here.

Pin No.	Function	Pin No.	Function
1	Return switch	7	Iris position
2	VTR trigger	8	IRIS A/R INPUT
3	GND	9	EXTENDER position
4	Lens AUTO/MANU control	10	ZOOM position
5	IRIS control	11	—
6	+12V DC	12	—

5 [ZEBRA] Switch

When this switch is ON, a zebra pattern is imposed on the viewfinder or LCD areas having luminance levels in accordance with the menu settings made for the video signal. This pattern can be used as a reference for manual adjustment of the lens iris. Zebra patterns are also displayed during color bar display when this switch is set to ON.
☞ See "Zebra Pattern Display during Manual Adjustment" on page 80.

- The default value is 70% - 80%. The luminance level can be changed with the ZEBRA setting in the LCD/VF menu screen.
☞ See "ZEBRA" item on page 73.
- While this switch is pressed to the SKIN AREA side, the color tone areas specified with the SKIN COLOR ADJUST item on the ADVANCED PROCESS menu are indicated in the viewfinder. The switch returns to the OFF position when released.
☞ See "How to Use Skin Detail" on page 85.
- The Skin Detail color tone areas are not indicated while the color bar or VTR playback picture is shown in the viewfinder or on the LCD monitor.

6 [VTR] VTR trigger button (record start/stop button)

Recording start/stop can be done with this button. (It is interlocked with the VTR trigger button on the side section and the VTR trigger button on the lens section.)

7 [AUDIO LEVEL CH-1] CH-1 audio level control

Adjusts the audio level of the CH1 audio signal input. Normally, the camera is used with the control set to the maximum (10) position.
• To use this control, set the CH1 FRONT VR item on the AUDIO/VIDEO menu screen to "ENABLE".

2. CONTROLS, INDICATORS AND CONNECTORS

8 [AUTO WHITE/ACCU FOCUS] switch

White Balance:

- First, position a white object to occupy 80% of the centre of the screen.
- When the WHTBAL switch **15** on page 13 is set to A or B, setting this switch to the upper position ("AUTO WHITE") will provide automatic adjustment for white balance.

* It is not activated in preset, full auto shooting, full-time auto white balance and color bar modes.

☞ See "White Balance Adjustment" on page 48.

ACCU-FOCUS:

- When this switch is pressed down to "ACCU FOCUS", the lens iris will be forced to open for approximately ten seconds.
- The depth of field can be reduced and the lens focusing can be adjusted more accurately.

CAUTION:

- As the automatic shutter is activated up to 1/10000, flicker may appear on the screen depending on the lighting conditions (such as a fluorescent lamp, etc.)
- This operation is not effected in the LOLUX mode.

9 Lens mounting ring/Lens lock lever

Hold the lens and use the lever to turn the ring anticlockwise to release lens.

To mount lens make sure the lens guide pin fits well, and then turn the ring clockwise until firm.

☞ See "Attaching the Zoom Lens" on page 30.

10 [FILTER] Color temperature conversion filter control knob

This knob switches the internal color temperature filters. (3200K, 5600K + 1/8ND, 5600K, 5600K + 1/64ND)

☞ See "Camera Settings" on page 45.

2. CONTROLS, INDICATORS AND CONNECTORS

2-2 Right Side Section

[Camera Setting Section]

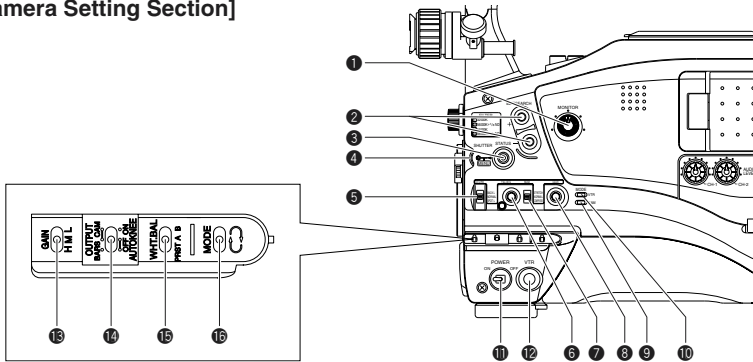

- 1 [MONITOR] Audio monitor volume control**
Adjusts the volume of the monitoring loudspeaker and earphone.
- 2 [EDIT SEARCH +/-] +/- button for edit search**
Pressing this button in the record-standby mode plays back the tape while the button is being pressed.
- While the + button is pressed, playback takes place at the normal speed. When the button is released, the standby mode is reengaged at the point where the button is released.
 - While the - button is pressed, playback takes place at -1 times the normal speed (reverse playback). When the button is released, the standby mode is reengaged at the point where the button is released.
- 3 [STATUS] Status/Menu button**
- Pressing this button in the normal screen mode (condition in which the menu screen is not shown) displays a status screen in the viewfinder or on the LCD monitor. The displayed status screen changes each time the button is pressed.
☞ See "Status Screens" on page 20.
 - Pressing this button for more than 1 second in the normal screen mode displays the menu screen in the viewfinder or on the LCD monitor. Pressing this button while the menu screen is displayed in the viewfinder or on the LCD monitor makes the menu screen disappear.
☞ See "Setting Menu Screens" on page 66.
- 4 [SHUTTER] Shutter/Menu dial**
- Every time this dial is pressed while in the normal screen mode (when the menu screen is not displayed), the shutter speed switches between on/off.
 - When this dial is turned 1 click up or down in the normal screen mode, the shutter speed indicator is shown for about 3 seconds on the LCD monitor or in the viewfinder. The shutter speed is changed when this dial is turned while the shutter speed indicator is shown.
☞ See "Adjusting the Shutter Speed" on page 81.

- When this dial is turned upward or downward while the menu screen is displayed, the cursor (▶) also moves upward or downward to allow selection of items in the menu. To change the setting value of the item, press this dial. When the setting value starts blinking, turn this dial upward or downward to change the setting.
☞ See "Setting Menu Screens" on page 66.
- 5 [AUTO IRIS] Auto iris level switch**
This switch selects the automatic iris adjustment reference value according to the condition in which the camera is used.
- BACK L : Under back light (Opens the iris about 1 step from the standard level.)
- NORMAL : Normal condition
- SPOT L : Under spotlight (Closes the iris about 1 step from the standard level.)
☞ See "SWITCH FUNCTIONS" on page 84.
- 6 [FULL AUTO] Full auto shooting ON/OFF button and indicator**
- This switch toggles the full auto shooting function on and off.
 - The indicator lights when in the full auto mode.
 - Full auto shooting combines the auto iris, auto level control (ALC) to automatically adjust the video signal level and the white balance to their optimum levels. The audio recording level will operate in the auto adjustment mode.
 - The iris is placed in automatic mode even if the iris mode switch of the lens is in manual.
 - The gain will vary continuously to the maximum of +18 dB. The shutter speed will vary continuously to the minimum of 1/240 of a second.
☞ See "Full Auto Shooting (FAS) function" on page 84.

- 7 [BLACK] Black stretch/black compression switch**
Switches the gain for the dark section of the image. Set to an appropriate position depending on the video signal to be shot.
- STRETCH** : By stretching the signal only for the dark section, contrast in the dark sections of the image is enhanced.
- NORMAL** : Standard mode.
- COMPRESS** : When an entire image is relatively light and the contrast is low, the gain of the dark sections is compressed to increase the contrast.
- 8 [LOLUX] LOLUX On/Off button**
This button toggles the LOLUX mode on and off.
- LOLUX gain gives extremely low light level sensitivity for special applications. This will result in an increase of 30 dB in the LOLUX mode.
 - The gain up value can be selected from the menu.
☞ See page 69.
 - LOLUX operation takes priority over normal gain setting.
 - If the unit is placed in the LOLUX mode when it is in full auto shooting mode, the auto level control (ALC) (one of the full auto shooting functions) will be made inactive, so that the LOLUX mode is given preference (FAW still remains active).
☞ See "GAIN BOOST UNDER LOLUX CONDITION" on page 83.
- 9 [CAM] Camera mode indicator**
This indicator lights when the camera is in the Camera mode. To record the camera image, press the MODE switch 16 to turn on this indicator. When the power is turned on, the mode becomes the Camera mode.
- 10 [VTR] VTR mode indicator**
This indicator lights when the camera is in the VTR mode. To perform VTR playback or input the DV signal from the DV connector 6 on page 19, press the MODE switch 16 to turn on this indicator.
- 11 [POWER] Power ON/OFF switch**
This switch is used to turn the power on and off. "POFF" is displayed on the LCD monitor or in the viewfinder when the power is turned off.
* Wait 5 seconds or more before turning the power on again after it has been turned off.
- 12 [VTR] Trigger button (Recording Start/Stop)**
This button is used to start and stop recording. (It is interlocked with the VTR trigger button on the front and the VTR trigger button on the lens section.)
- 13 [GAIN] Sensitivity selector switch**
Electronically boosts the light sensitivity when there is insufficient illumination on the subject. The boosting level differs depending on the switch position as follows: (Factory presets)
- L : 0 dB (no boosting is applied)
- M : 9 dB (boosted to approximately 3 times the original)
- H : 18 dB (boosted to approximately 8 times the original)
- The boosting level for each switch position can be changed with the CAMERA OPERATION MENU screen.
☞ See page 69.
 - The more the boosting level is increased, the more the resulting image will be noisy.

- 14 [OUTPUT] Color bar/Camera/Auto knee switch**
This switch is used to select the output signal. When the video signal from the shooting camera is selected, the auto knee function is available.
- CAM. AUTO KNEE ON**: Outputs the video signal from the shooting camera. In this mode, the auto knee function is available.
- CAM. AUTO KNEE OFF**: Outputs the video signal from the shooting camera. In this mode, the auto knee function is not available.
- BARS**: Outputs the color bar signal. In this mode, the auto knee function is not available. Set to this position when adjusting the video monitor or when recording the color bar signal. Color bars will not appear when Full Auto is set to ON or when in the VTR mode.
- AUTO KNEE function**
When shooting a foreground subject, such as a human being, etc., with a high-brightness background, if the brightness level is set for the foreground subject, the background image will be blurred with white. In such a case, a clearer background is obtained when the auto knee function is used.
- It is effective especially in the following cases:
- When shooting a human being indoors with a view to the landscape out through a window.
 - When shooting a human being in the shade on a fine day.
 - When shooting a high-contrast scene.

CAUTION:
If a fast moving high-brightness section like a car in sunlight is shot, the auto knee function may change the brightness of the entire image along with the motion of the object. In this case, set the auto knee function to OFF.

- 15 [WHT.BAL] White balance switch**
Three white balance modes are selectable with this switch.
- B** : If white balance is performed with the switch in this position, it will be memorized into B.
- A** : If white balance is performed with the switch in this position, it will be memorized into A.
- PRST (PRESET)** : A non-erasable white balance setting at 3200K.
- FAW (Full-time Auto White) mode can be set to A, B or PRESET with the CAMERA OPERATION menu. ☞ See page 69.
 - In the FAW mode, video color temperatures are constantly sampled for automatic adjustment to a proper white balance.
- 16 [MODE] Mode switching switch**
This is a switch to select either the Camera mode or the VTR mode. Each time this switch is pressed upward, the mode is switched to either the Camera mode or the VTR mode and the CAM indicator 9 or VTR indicator 10 lights in accordance with the selected mode.
- Select the Camera mode to record the camera image.
 - Select the VTR mode to playback or to input the DV signal from the DV connector 6 on page 19.
 - When the power is turned on, the mode becomes the Camera mode.

2. CONTROLS, INDICATORS AND CONNECTORS

2-2 Right Side Section (Cont'd)

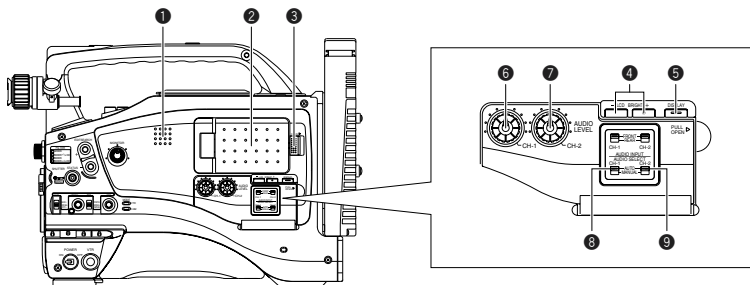

1 Monitoring loudspeaker

In the Camera mode, the input sound can be EE monitored. In the VTR mode, the speaker outputs the VTR playback sound. The sound to be output is selected with the MONITOR SELECT switch ⑨.

- The sound level is adjusted with the MONITOR sound level button ① on page 12. The sound from this speaker is not output if an earphone is plugged into the PHONES jack ⑤ on page 18. This speaker also outputs various warning sounds superimposed on other sound. See "Alarm Sounds" on page 89.

2 LCD door

LCD monitor door.
The LCD monitor is located on the inner side of the door. The LCD monitor can be viewed when this door is opened. The door can be turned to change the orientation of the LCD monitor, and it can be rotated so that it can be accommodated in the main body of the camera. See page 40.

3 LCD door lock and release knob

To open the LCD door, move this knob in the direction toward the rear section.

4 [LCD BRIGHT +/-] LCD brightness +/- button

This button is for adjusting the brightness of the LCD monitor display.

- Pushing the button in the + direction makes the monitor brighter.
- Pushing the button in the - direction makes the monitor darker.
- Pushing the +/- buttons simultaneously returns the setting to the standard setting.

5 [DISPLAY] Display button

This button is for turning the LCD monitor display ON/OFF and selecting the display mode.
When this button is pressed for a long time, the LCD monitor display is turned ON or OFF.
Each time this button is briefly pressed while the LCD monitor display is turned on, the display mode changes as shown in the following.

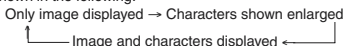

6 [CH-1 AUDIO LEVEL] CH1 audio level control

Adjust the audio level of the CH1 audio channel with this control.

- To use this control, set the CH1 AUDIO SELECT switch ⑧ to "MANUAL". This control works regardless of the setting of CH1 FRONT VR item on the AUDIO/VIDEO menu screen.

To use this control, set the AUDIO LEVEL CH-1 control switch on the front section (⑦ on page 10) to the maximum (10) position, or set the CH1 FRONT VR item on the AUDIO/VIDEO menu screen to "DISABLE".

7 [CH-2 AUDIO LEVEL] CH-2 audio level control

Adjust the audio level of the CH2 audio channel with this control.

- This control is valid only when the CH-2 AUDIO SELECT switch ⑨ is set to "MANUAL".

8 [CH-1 AUDIO SELECT] CH-1 audio selector switch

This switch is used to select the method for adjusting the audio level of the CH-1 audio channel.

AUTO : The audio level is held at the reference level even when sounds greater than the reference level are input.
The audio level does not increase when the input level is low.

MANUAL : The audio level can be adjusted with the CH-1 AUDIO LEVEL control ⑥ or the AUDIO LEVEL CH-1 control ⑦ on page 10.

To use the AUDIO LEVEL CH-1 control on the front section, the CH1 FRONT VR item on the AUDIO/VIDEO menu screen should be set to "ENABLE".

9 [CH-2 AUDIO SELECT] CH-2 audio selector switch

This switch is used to select the method for adjusting the audio level of the CH-2 audio channel.

AUTO : The audio level is held at the reference level even when sounds greater than the reference level are input.
The audio level does not increase when the input level is low.

MANUAL : The audio level can be adjusted with the CH-2 AUDIO LEVEL control ⑦.

2. CONTROLS, INDICATORS AND CONNECTORS

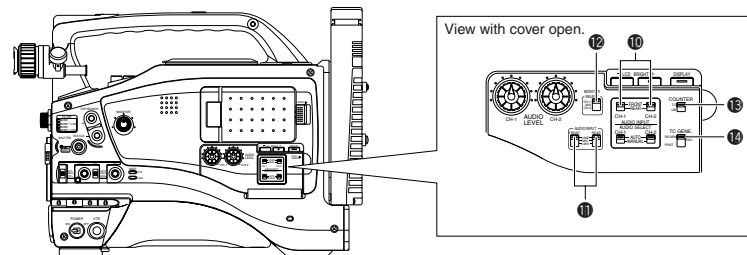

10 [CH-1/CH-2 AUDIO INPUT] CH-1/CH-2 audio input selector switch

This switch is used to select the input sound of the CH1 or CH2 audio channel. It is selected for each of the CH1 and CH2 channels.

FRONT : The sound from the FRONT AUDIO IN connector on the front side section is input.

REAR : The sound from the REAR AUDIO IN connector on the rear side section is input.

11 [FRONT/REAR AUDIO INPUT] Front/rear audio input signal selector switch.

This switch is used to select the input sound signal from the FRONT AUDIO IN connector and the REAR AUDIO IN connector.

LINE : Set to this position when connected to audio equipment, etc. The reference input level is +4 dBs.

MIC : Set to this position when the microphone is connected. The reference input level is -60 dBs.

+48V : Set to this position when a microphone requiring +48 V power supply (phantom microphone, etc.) is connected. This connector supplies +48 V DC current.

When using the provided microphone connected to the FRONT AUDIO IN connector, set the FRONT AUDIO INPUT switch to this setting.

CAUTION:

When connecting a component that does not require +48 V power supply, make sure that the switch is not set to +48V before the component is connected.

12 [MONITOR SELECT] Audio monitor selector switch

This switch is used to select the monitor sound output and playback sound output from the monitoring loudspeaker ① or the PHONES jack ⑤ on page 18.

CH-1 : The CH1 channel audio is output.

MIX : CH1 and CH2 channel audio are output mixed. When this setting is selected, the menu screen can be used to select whether the mixed sound or stereo sound should be output via the PHONES jack. (AUDIO MONITOR item on the AUDIO/VIDEO menu screen)

When AUDIO MONITOR in the AUDIO/VIDEO menu screen is set to "STEREO", only the audio of CH-1 is output from the monitoring loudspeaker.

CH-2 : The CH2 channel audio is output.

See "Outputting CH-3, CH-4 Channel Audio" on page 59.
See "AUDIO/VIDEO Menu Screen" on page 72.

CAUTION:

Make sure to move switches all the way. Do not leave a switch stopped in a midway position. Noise will be generated and operation irregularities will occur.

13 [COUNTER] Counter display switch

Selects the contents displayed on the TC counter of the LCD monitor or in the viewfinder. (This switch works when the TC/UB item on the LCD/VF (2/2) menu screen is set to ON.)

TC : Set to this position to display time code values.

UB : Set to this position to display the user's bits values.

14 [TC GENE.] Time code generator setting switch

Switch for setting the time code generator to preset mode or regeneration mode. It is also used to select the time code run mode when the preset mode is selected.

PRST-FREE : The preset mode is selected, and the time code run mode becomes the FREE run mode.

Set to this position to record with the time code or user's bits set anew (preset). In this setting, the time code always operates in the run mode.

* If this setting is used when recording scenes one after another, the time codes become discontinuous at the transition points between scenes.

PRST-REC : The preset mode is selected, and the time code run mode becomes the REC run mode. Set to this position to record with the time code or user's bits set anew (preset). The time code operates in the run mode during recording only. If this setting is used when recording scenes one after another, the time codes are recorded as continuous time codes.

REGEN : Regeneration mode, in which the unit reads existing time codes on the tape and records time codes in continuation of the existing ones. Set to this position when you want to add additional time codes to time codes already recorded on the tape.

MEMO:

Preset of time code and user's bits is performed on the TC/UB/CLOCK menu.

See "TIME CODE OPERATION" on page 62.

See "TC/UB/CLOCK Menu Screen" on page 75.

2. CONTROLS, INDICATORS AND CONNECTORS

2-3 Left Side Section

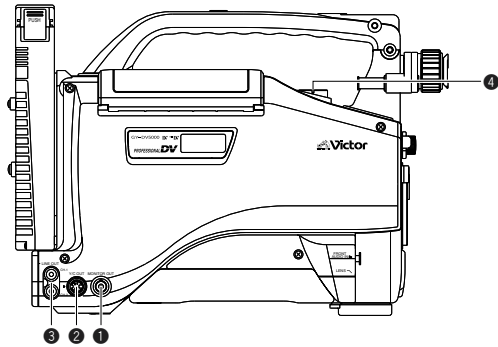

1 [MONITOR OUT] Monitor output connector (BNC)

- Composite video signal output connector.
 - Video signals with setup level are output. (Whether or not setup level output should be enabled or disabled can be selected with the SETUP item on the AUDIO/VIDEO menu screen.)
- Camera mode: The camera image is output.
VTR mode: The playback image is output in the VTR playback mode. When a DV signal (IEEE1394) is input, the EE image of the input video signal is output.

MEMO:

- When the OUTPUT CHAR. item on the OTHERS (1/2) menu screen is set to ON, the same on-screen indications as those on the viewfinder will be shown on the external monitor. (Black and white indications)
- The setup signal can be selected also for the EE output signal of the DV input.

2 [Y/C OUT] Y/C output connector (4-pin)

- Output connector for separate YC video signal.
 - Video signals with setup level are output. (Whether or not setup level output should be enabled or disabled can be selected with the SETUP item on the AUDIO/VIDEO menu screen.)
- Camera mode: The camera image is output.
VTR mode: The playback image is output in the VTR playback mode. When a DV signal (IEEE1394) is input, the EE image of the input video signal is output.

MEMO:

- When the ASPECT RATIO item on the CAMERA OPERATION menu screen is set to LETTER, 16:9 aspect ratio distinction ID signal is output.
- When the OUTPUT CHAR. item on the OTHERS (1/2) menu screen is set to ON, the same on-screen indications as those on the viewfinder will be shown on the external monitor. (Black and white indications)
- The setup signal can be selected also for the EE output signal of the DV input.

3 [CH1/CH2 LINE OUT] CH1/CH2 line output connector (RCA)

- Output connector for audio signals.
- Outputs the input audio signal in the Camera mode.
 - Outputs the playback audio signal or DV signal in the VTR mode.

MEMO:

- Alarm sound is not output.

4 Microphone attachment holes

- For attaching the microphone holder KA-A50 (optional) when the optional microphone MV-P615U or MV-P618U is used.
- ⇒ See "Attaching the Microphone (optional)" on page 31.

2. CONTROLS, INDICATORS AND CONNECTORS

2-4 Top Section

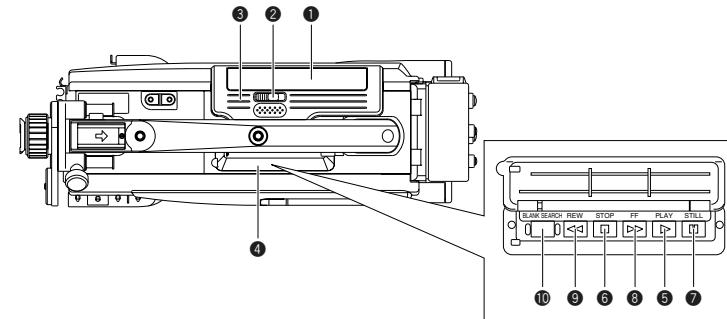

1 Cassette cover

- The cassette cover can be opened by sliding the OPEN knob 2. Open this cover to insert or remove a videocassette from the unit. Normally, this cover should be closed.

CAUTION:

To prevent foreign objects from entering the internal parts of the VTR unit, do not leave the unit with the cover open for extended periods of time.

2 [OPEN] Cassette cover lock knob

- Slide this knob to open the cassette cover.

3 [EJECT] button

- Located inside the cassette cover.
Press this button to eject the videocassette.

MEMO:

- It takes a few seconds before the videocassette is ejected. Do not close the cassette cover during the eject operation.
- Do not touch the cassette insertion slot or cassette during the eject operation. This could result in damage.
- Eject operation is not possible while the power is off.

4 Operation cover

- Open this cover when operating in the playback mode. Otherwise, keep this cover closed.
This cover can be opened by sliding it to the side.

MEMO:

- When the STOP button (6) is pressed in the Camera mode to set the VTR operation mode indicator to indicate STOP, playback operations become possible.

5 [PLAY] button

- Press to start playback. During still picture playback and search mode, press this button to return to the normal playback mode.

* If the auto tracking is active at the moment the play mode is entered, the playback video will be interfered with digital noise.

6 [STOP] button

- Press to enter the stop mode.

7 [STILL] button

- Press to enter the still picture mode during playback, in the stop mode or in the search mode.

When the still picture mode has continued for about 3 minutes, the unit automatically switches to the stop mode. (Tape protect mode)

8 [FF] Fast forward button

- Press this button to fast forward the tape.

- Pressing this button in the stop or rewind mode initiates the fast forward mode.
- Pressing this button during playback, still picture playback or reverse search initiates forward search.

9 [REW] Rewind button

- Press this button to rewind the tape.

- Pressing this button in the stop or fast forward mode initiates the rewind mode.
- Pressing this button during playback, still picture playback or forward search initiates reverse search.

10 [BLANK SEARCH] button

- Press this button to locate blank parts (unrecorded parts) on the tape, such as the end point of a recording. Blank search starts when this button is pressed in the stop mode. When a blank part (unrecorded part) on the tape is detected, the unit enters the STILL status in the VTR mode and the Standby status in the Camera mode.

2. CONTROLS, INDICATORS AND CONNECTORS

2-5 Rear Section

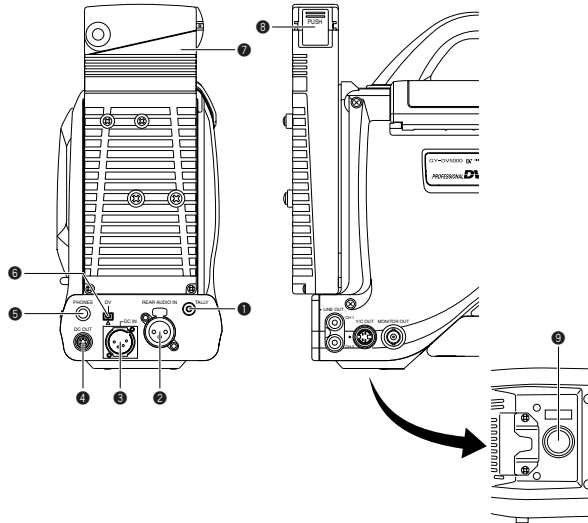

1 [TALLY] Tally lamp

This lamp lights up when the GY-DV5000 enters the record mode. It blinks during the transition to the record mode.

- Use the BACK TALLY item on the OTHERS (2/2) menu screen to select whether or not the lamp should light and the lighting pattern.

☞ See "BACK TALLY" on page 78.

2 [REAR AUDIO IN] Audio input connector on the rear section

Connect external audio equipment or a microphone to this connector.

- Set the FRONT/REAR AUDIO INPUT switch 1 on page 15 in accordance with the connected equipment.
- To record the audio signal input through this connector, set the CH-1 or CH-2 AUDIO INPUT switch 1 on page 15 to "REAR". The audio from this connector is recorded on the channel set to "REAR".

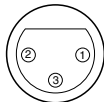

No.	Signal
①	GND
②	HOT
③	COLD

3 [DC IN] DC input connector (XLR 4-pin)

Power input connector for 12 V DC. Connect to the optional AA-P250 power adapter. When a cable is connected here, the power supply from the battery pack is interrupted and the source is switched to the power supplied through this connector.

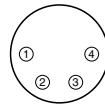

No.	Signal
①	GND
②	—
③	—
④	+12V

4 [DC OUT] DC output connector

Connector for power output to a wireless microphone transmitter, etc. The supply voltage is identical to the voltage supplied to the unit (DC 17 V max. 0.3 A).

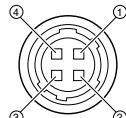

(Surface profile)

No.	Signal
①	GND
②	—
③	—
④	DC 12V (power through)

5 [PHONES] Earphone jack

This is a stereo mini-jack for connecting an earphone for audio monitoring. Plug in an earphone or headphone with a 3.5 mm diameter plug. The earphone can also be used to monitor alarm tones in accordance with the circumstances. The sound from the monitoring loudspeaker is interrupted when an earphone is connected here.

The audio channel to be output is selected with the AUDIO SELECT item on the AUDIO/VIDEO menu screen and MONITOR SELECT switch 2 on page 15.

The audio output level is adjusted with the Audio monitor volume control 1 on page 12.

2. CONTROLS, INDICATORS AND CONNECTORS

MEMO:

- The volume of the alarm sound is set with the ALARM VR LEVEL item on the OTHERS (2/2) menu screen.
- When using a stereotype jack and stereo sound should be output, the following setting should be performed.
Set the MONITOR SELECT switch to "MIX".
Set the AUDIO MONITOR item on the AUDIO/VIDEO menu screen to STEREO.

6 [DV] connector

Using a DV cable (optional), a digital video component with DV connector can be connected here.

This connector is used for input and output of the DV signal or to input the VTR control signal from a digital video component with DV connector.

To record the DV signal from this connector, set the unit to the VTR mode. (Press the MODE switch 16 on page 13 upward to turn on the VTR indicator.)

• Camera mode:

The DV compressed signal (IEEE1394) of the camera image is output.

• VTR mode:

The DV input signal from this connector can be recorded on tape. During playback, the tape playback DV compressed signal is output.

MEMO:

To receive FF/REW remote control signals from this connector, select the setting with the REM FF/REW MODE item on the OTHERS (1/2) menu screen.

7 Battery holder

Mount Flat shape type battery pack here.

☞ See "Using a Flat Shape Type Battery Pack" on page 34.

8 Battery holder lock release knob

This knob is used to open the battery case cover. Press the knob while turning to open the cover.

9 [BREAKER] Breaker button

The breaker trips when the power consumption exceeds the capacity.

If the breaker trips, confirm that there are no abnormalities and that the power consumption does not exceed the rated wattage. If no abnormalities are detected, press the BREAKER button before turning the power ON again to put the camera in the operating status.

If the unit still does not work normally, please consult the person in charge of professional video equipment at your nearest JVC-authorized service agent.

2. CONTROLS, INDICATORS AND CONNECTORS

2-6 Indications on the LCD Monitor and in the Viewfinder

In addition to showing the EE image and the playback picture, the LCD monitor and viewfinder are also used for the following character displays. To show characters on the LCD monitor, press the DISPLAY button briefly.

- Status screens (screens for checking the current camera settings)
- Alarm message display
- Auto white display (only displayed in the Camera mode)
- Safety zone display (only displayed in the Camera mode)
- Menu setting screens

MEMO:

- When the OUTPUT CHAR. item on the OTHERS (1/2) menu screen is set to ON, the character displays mentioned above are also output through the MONITOR OUT connector and Y/C OUT connector.

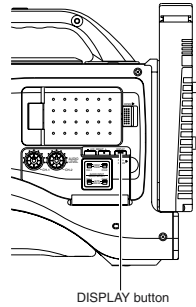

DISPLAY button

■ Status Screens

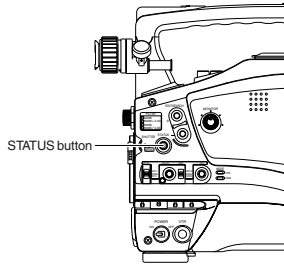

STATUS button

Press the STATUS button while normal screen is displayed to show one of the status screens. The contents of the status display are divided into those for the Camera mode and those for the VTR mode.

- Each time the STATUS button is pressed in the Camera mode, one of four status screens is displayed. (STATUS 0, STATUS 1, STATUS 2, STATUS 3)
- One type of screen is displayed in the VTR mode (DV signal input mode).

MEMO:

- When the STATUS button is pressed for 1 second or longer, the menu setting screen is displayed. To display the Status screen while the menu setting screen is displayed, press the STATUS button to return to the normal screen.
- The DISPLAY button can be pressed to show characters alone in magnified size on the LCD monitor.

• Camera mode

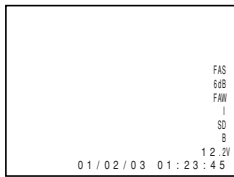

STATUS 0

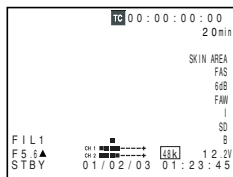

STATUS 1

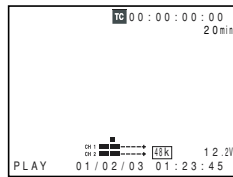

STATUS

• VTR mode (DV signal input mode)



STATUS 3

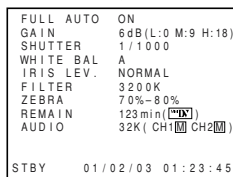

STATUS 2

2. CONTROLS, INDICATORS AND CONNECTORS

■ Status Screens in the Camera Mode

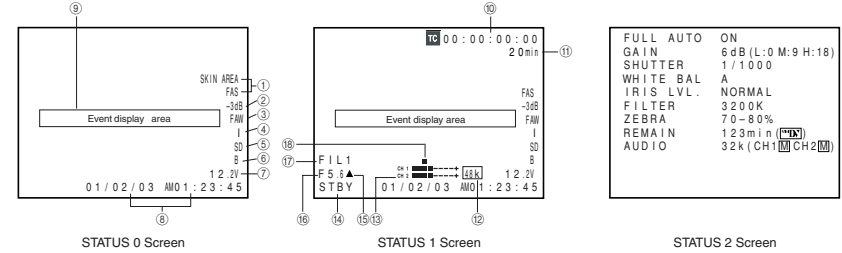

• Status 0

No.	Item	Contents
①	Indication of various function operations	ACCU-FOCUS : Blinks during the ACCU-FOCUS operation. SKIN AREA : Blinks while the skin tone detail color area is displayed. ALC : Displayed when ALC function alone is ON. FAS : Displayed when the Full Auto Shooting function is ON. S : Displayed when the SHUTTER or V.SCAN function is ON.
②	Gain operation indication	* dB : Indicates gain value when gain is other modes than 0 dB, LOLUX and ALC. LUX : Indicated when LOLUX is ON.
③	Indication of FAW operation	FAW : Indicated when Full Auto White Balance is ON.
④	Indication of Iris level operation	I : Indicated when IRIS BACK LIGHT or IRIS SPOT LIGHT is selected.
⑤	Indication of skin tone detail color operation	SD : Indicated when skin tone detail is ON.
⑥	Indication of Black operation	B : Indicated when BLACK STRETCH or BLACK COMPRESSION is ON.
⑦	Voltage indication	(Example) 12.2 V : Indicates battery voltage in 0.1 V steps. * This indication blinks when the remaining battery power is low.
⑧	Indication of date and time	Indicates the date and time. Whether or not the date and time should be displayed as well as the display style are set on the TIME/DATE menu.
	LCD BRIGHT indication	When the brightness of the monitor screen is adjusted with the LCD BRIGHT button, the date and time indications and the ⑧ VTR mode indication are turned off and the LCD BRIGHT indicator is displayed. (Example) BRIGHT +5 ●●●●●●●● Numeric value : Any of -5, -4, -3, -2, 0, +1, +2, +3, +4, +5.

⑨ Event Indication

When the Gain or Shutter Speed is changed manually, the setting condition is displayed for about 3 seconds at the time the change is made.



Setting Condition	Contents of Indications
When the gain value is changed	GAIN -3 dB, 0dB, 3dB, 6 dB, 9 dB, 12 dB, 15 dB, 18 dB.
When gain is ALC	GAIN ALC
When the LOLUX mode is ON/OFF	LOLUX ON, LOLUX OFF
When the AUTO KNEE is ON/OFF	AUTO KNEE ON, AUTO KNEE OFF
When the FULL AUTO is ON/OFF	FULL AUTO ON, FULL AUTO OFF
When the ZEBRA is ON/OFF	ZEBRA ON, ZEBRA OFF
When the shutter speed is changed	SHUTTER 1/7.5, 1/15, 1/30, 1/60, 1/100, 1/250, 1/500, 1/1000, 1/2000, 1/4000, 1/10000
When the variable shutter speed is changed	V. SHUTTER 1/60.1 to 1/2084.6
When the shutter is OFF (Shutter speed: 1/60)	SHUTTER OFF
When the white balance value is changed	(Example) WHITE BAL A <3200K> Numeric value : Any of 2300, 2500, 2800, 3000, 3200, 3400, 3700, 4300, 5200, 6500, 8000

2. CONTROLS, INDICATORS AND CONNECTORS

2-6 Indications on the LCD Monitor and in the Viewfinder (Cont'd)

● Status 1

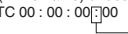
In addition to the information on the Status 0 screen, this screen displays the following items.











No.	Item	Contents
⑩	Time Code (TC)/User's Bits (UB) indication	Indicates the time code (h:m:s:frame) or user's bits data. (Example) Time code TC 00 : 00 : 00  <div style="display: flex; justify-content: center; align-items: center; gap: 20px;"> <div style="text-align: center;"> User's bits UB FF EE DD 20 </div> <div style="text-align: center;"> Non-drop frame: Colon (:) Drop frame: Dot (.) </div> </div> <p>Whether or not to display this item is set with the TC/UB item on the LCD/VF (2/2) menu screen. Whether the time code or user's bits should be shown is selected with the COUNTER switch inside the side cover.</p>
⑪	Remaining tape indication	Remaining tape indication (displayed in 1-minute steps) This indicator blinks when remaining tape time is equivalent to less than 3 minutes. Whether or not to display this item is set with the TAPE REMAIN item on the LCD/VF (2/2) menu screen. * When inserting a brand-new tape, the remaining tape time is not indicated. When the tape has been run, the indication will appear. * The remaining tape indication is to be regarded only as a guide. * When the unit is used at low temperatures, it may take a while before the indication of the remaining tape time appears.
⑫	Audio sampling frequency indication	32 K : Indicated when the AUDIO MODE item on the AUDIO/VIDEO menu screen is set to 32 K. (Audio is recorded with 12-bit, 32 kHz sampling.) 48 K : Indicated when the AUDIO MODE item on the AUDIO/VIDEO menu screen is set to 48 K. (Audio is recorded with 16-bit, 48 kHz sampling.)
⑬	Audio level meter indication	Displays the CH-1, CH-2 audio level meters. Whether or not to display this item is set with the AUDIO DISPLAY item on the LCD/VF (2/2) menu.
⑭	VTR mode indication	STBY : In record standby mode (record-pause mode) REC : During recording ED.FWD : Edit search in forward direction ED.REV : Edit search in reverse direction PLAY : During playback FF : During fast forward REW : During rewind STL : During still picture playback mode BSRH : During blank search FWD : During playback in forward direction (FWD1: About X5 speed, FWD2: About x9 speed, FWD3: About X20 speed) REV : During playback in reverse direction (REV1: About X5 speed, REV2: About x9 speed, REV3: About X20 speed) STOP : Stop mode (Tape protect mode) EJECT : Cassette being ejected --- : No tape loaded
⑮	Iris indicator display	▲ : Iris set higher than normal ■ : Iris set to normal ▼ : Iris set lower than normal
⑯	Iris F-value indication	Indicates the F-number of the connected lens. OPEN, F2, F2.8, F4, F5.6, F8, F11, F16, CLOSE It is not displayed when the lens is removed. For some lenses, no display appears. The indication can be switched ON/OFF with the F.NO/IRIS IND. item on the LCD/VF (1/2) menu screen.
⑰	Filter position indication	Indicates the current filter position FIL1, FIL2, FIL3, FIL4 The indication can be switched ON/OFF with the FILTER item on the LCD/VF (1/2) menu screen.
⑱	Standard audio level indication	The level at which audio is recorded on the tape is indicated by "■". -20dB, -12dB * See "AUDIO REF. LEVEL" on page 72. <div style="text-align: center;">  </div>

2. CONTROLS, INDICATORS AND CONNECTORS

● Status 2

This screen displays the camera setup statuses.

Event display is not available while this screen is displayed.

Indication	Indication Contents
FULL AUTO	ON, OFF
GAIN	-3 dB, 0 dB, 3dB, 6 dB, 9 dB, 12 dB, 15dB, 18 dB, LOLUX, ALC
SHUTTER	OFF, 1/7.5, 1/15, 1/30, 1/60, 1/100, 1/250, 1/500, 1/1000, 1/2000, 1/4000, 1/10000 (STEP), V.SCAN 1/60.1 to 1/2084.6 (VARIABLE), EEI (in ALC mode)
WHITE BAL.	A, B, PRESET, FAW
IRIS LEVEL	BACK L, NORMAL, SPOT L
ZEBRA	70-80%, 85-95%, OVER95%, OVER100%
FILTER	3200K, 5600K+1/8ND, 5600K, 5600K+1/64ND
REMAIN	Remaining tape time (min) or tape type (Example: 95 min ())  (when using MiniDV cassette),  (when using standard cassette),  (when using DVCAM cassette) * DVCAM indicates IC Memory compatible DVCAM cassette. In the case of other DVCAM cassette than IC Memory compatible cassette,  or  is indicated.
AUDIO	Audio sampling frequency and audio level adjustment method (Example) 32K (CH1  CH2 )  (Auto)  (Manual)

● Status 3

This screen only displays date and time, event display and warning indications.

* Whether or not date and time should be displayed and the display style are set on the TIME DATE MENU screen.

☞ page 43 "Displaying the Time and Date on the Screen"

■ Status Screen in VTR MODE (DV Signal Input Mode)

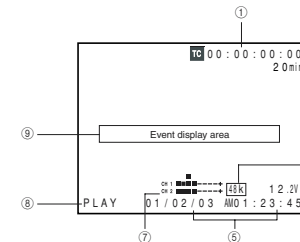

No.	Item	Contents
①	Indication of Time Code (TC)/User's Bits (UB)	In the playback mode, the recorded time code (hour, minute, second, frame) is displayed. Whether or not to display this item is set with the TC/UB item on the LCD/VF (2/2) menu screen. Whether to show the time code or the user's bits is selected with the COUNTER switch inside the side cover.
②	Remaining tape time	Remaining tape indication (displayed in 1-minute steps) This indicator blinks when remaining tape time is equivalent to less than 3 minutes. Whether or not to display this item is set with the TAPE REMAIN item on the LCD/VF (2/2) menu screen. * When inserting a brand-new tape, the remaining tape time is not indicated. When the tape has been run, the indication will appear. * The remaining tape indication is to be used only as a guide. * When the unit is used at low temperatures, it may take a while before the indication of the remaining tape time appears.
③	Voltage indication	(Example) 12.2 V : Indicates battery voltage in 0.1 V steps. * This indicator blinks when the remaining battery power is low.

2. CONTROLS, INDICATORS AND CONNECTORS

2-6 Indications on the LCD Monitor and in the Viewfinder (Cont'd)

No.	Item	Contents
⑤	Time/Date indication	Recorded data are displayed during playback, fast forward, and rewind. During recording, the data from the DV connector is displayed. In the stop mode, the current data is displayed. Whether or not the date and time should be displayed and the display style are set on the TIME/DATE menu screen. When the date and time have not been set, the following indication appears. --/--/-- --:--:--
⑥	Audio sampling frequency indication	The audio sampling frequency used for the recording is displayed during playback. (32 K, 48 K, 44.1 K)
⑦	Audio level meter indication	Displays the audio level meters during playback. Whether or not to display this item is set with the AUDIO item on the LCD/VF (2/2) menu screen.
⑧	VTR mode indication	Indicates the VTR operation status [STBY, STOP, PLAY, REC, FF, REW, FWD, REV, STL, BSRH, --- (No tape loaded)]
⑨	Event display	BLANK SEARCH : Indicates that blank search operation is in progress.

■ Magnified Status Indications on the LCD Monitor

The characters on the status screens can be showed alone in magnified size on the LCD monitor.

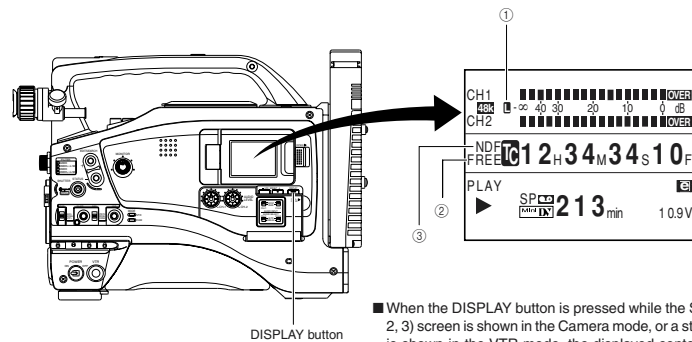

- When the DISPLAY button is pressed while the Status (0, 1, 2, 3) screen is shown in the Camera mode, or a status screen is shown in the VTR mode, the displayed contents change every time the DISPLAY button is pressed.
- Only image displayed → Characters shown enlarged
- Image and characters displayed ←

No.	Item	Contents
①	Audio Lock Indicator	Displayed during recording and playback when the audio signal is locked to the video signal.
②	Time Code Generator Setting Indicator	Indicates the set status of the TC GENE switch on the side section. FREE : TC GENE switch is set to PRESET-FREE RUN MODE. RECR : TC GENE switch is set to PRESET-REC RUN MODE. REGN : TC GENE switch is set to REGEN MODE.
③	Drop/Non-drop Indicator	Displayed during playback of a tape recorded in drop frame or non-drop frame mode. DF : During playback of a tape recorded in drop frame mode. NDF : During playback of a tape recorded in non-drop frame mode.

2. CONTROLS, INDICATORS AND CONNECTORS

■ Alarm Message Display

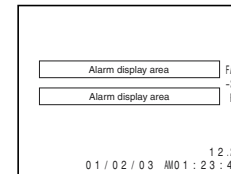

- The following alarm messages are displayed while the Status(0, 1, 3) screen is shown in the Camera mode, or a status screen is shown in the VTR mode. If an alarm is generated while the Status 2 screen is shown, the Status 0 screen returns to display the alarm.
- When an abnormality occurs in the VTR, a warning message with an error code is displayed.

Alarm Indication	Contents
PAL INHIBIT	Displayed when attempt is made to play back a tape recorded with PAL signal.
REC INHIBIT	Displayed when an unrecordable videocassette (the switch on the back of the cassette is set to "SAVE") is loaded.
COPY INHIBIT	Displayed when attempt is made to record a copy-guarded signal.
LOW VOLTAGE	Displayed when remaining battery power becomes low.
TAPE NEAR END	Flashes when the remaining tape is 3 minutes or less in the shooting mode. It is not shown in the playback mode.
TAPE END	Displayed when the tape has reached its end.
INVALID TAPE!	Displayed when a data tape for PC use or DVC PRO cassette is used. The tape is ejected.
LP TAPE INVALID!	Displayed when attempt is made to playback a tape recorded in the LP mode.
NO TAPE!	Displayed when no videocassette is inserted and the VTR trigger button is pressed.
NO DV SIGNAL!	Displayed when there is no input to the DV connector and recording is attempted.
COPY GUARD!	Displayed when attempt is made to play back a copy-guarded tape.
CLEANING TAPE!	Displayed when a head cleaning tape is inserted.
HEAD CLEANING REQUIRED!	Displayed when head is clogged. Head cleaning is necessary.
CLOSE CASSETTE COVER!	Displayed when operation is attempted while the cassette cover is open.
OPEN CASSETTE COVER!	Displayed when the cassette cover is closed during the eject operation.
VCR WARNING (Error code) (Example) 7001 DRUM MOTOR FAILURE	Displayed in case abnormalities occur in the VCR, or when condensation occurs in the unit. For details, see page 88.

2. CONTROLS, INDICATORS AND CONNECTORS

2-6 Indications on the LCD Monitor and in the Viewfinder (Cont'd)

■ Auto White Balance Indication (Camera mode only)



The AUTO WHITE indication and the result of the operation are displayed during the auto white balance adjustment operation.
 * See "Auto White Balance Adjustment" on page 48.

■ Safety Zone Indication (Camera mode only)

The indication of the following safety zone and center mark indications can be turned ON/OFF with the SAFETY ZONE item and CENTER MARK item on the LCD/VF (1/2) menu screen. * See page 73.

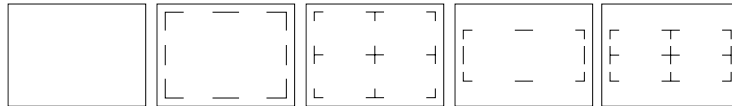

SAFETY ZONE
CENTER MARK

OFF
OFF

NORMAL
OFF

NORMAL
ON

16:9
OFF

16:9
ON

MEMO:

When the ASPECT RATIO item on the CAMERA OPERATION menu screen is set to LETTER, 16:9 is indicated even if the SAFETY ZONE item is set to NORMAL.

■ Menu Setting Screen

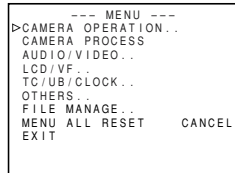

TOP MENU screen (Camera mode)

Screen used for making various settings.

The Menu Setting Screen appears when the STATUS button is pressed for 1 second or more.

* See "Setting Menu Screens" on page 66.

2. CONTROLS, INDICATORS AND CONNECTORS

2-7 Lens (Optional)

[S14 x 7.3B12]

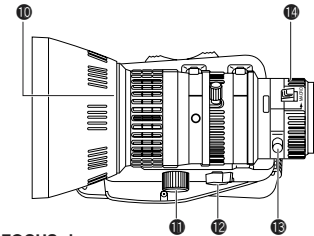
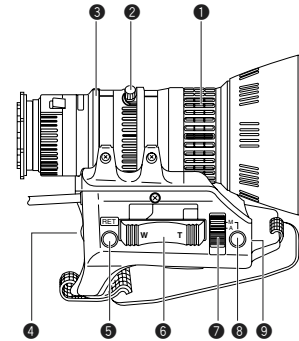

⑦ IRIS mode switch

- A : Activates the auto iris feature.
- M : Allows manual iris control.

⑧ Momentary auto iris button

When the IRIS MODE switch ⑦ is at "M", pushing this button activates the Auto Iris Function while it is held down only.

⑨ [S] IRIS speed adjusting control

For adjusting the iris operation speed.

MEMO:

If the speed becomes too fast, hunting may occur. To avoid the phenomena described above, perform adjustment again.

⑩ FILTER thread

Protect the lens with a clear filter or UV filter by screwing the filter onto the thread inside the lens hood from the front. Other filters can be used for various effects.

CAUTION:

The filter thread section rotates, so pay attention when mounting a polarizing filter.

⑪ ZOOM servo connector

Connect an optional zoom servo unit here.

⑫ ZOOM mode knob

- S : Servo zoom mode. Allows operation by the zoom servo control lever ⑥.
- M : Manual zoom mode. Allows zoom control by the zoom lever/ring ②.

⑬ BACK FOCUS ring/fixing screw

For back focus adjustment only. Secure with the screw knob after adjustment.

* See "Back Focus Adjustment" on page 47.

⑭ Macro focusing ring (for close-up shooting)

By rotating this ring in the direction of the arrow, close-up shooting of very small objects becomes possible.

Normal focus adjustment and zooming are not available in the macro mode.

To shoot images in the macro mode, set the focus ring ① to the infinite position (∞) and the zoom ring ② to the maximum wide-angle position. To adjust the focus of the macro image, rotate this ring in the direction of the arrow until the object is focused.

CAUTION:

- The back-focus knob is located close to the macro ring, be careful not to mistake the back-focus knob for the macro ring.
- After the required operation, be sure to return the macro focusing ring to the normal position.

* See "Attaching the Zoom Lens" on page 30.

* See "Back Focus Adjustment" on page 47.

① FOCUS ring

Manual focus ring.

② ZOOM lever/ring

This is the manual zoom ring equipped with a zoom lever. To adjust the zoom manually, turn the zoom mode knob ⑫ to position "M".

③ IRIS ring

Manual iris ring. To activate the auto iris feature, set the Iris Mode switch ⑦ to "A".

④ [VTR] Trigger button

To start/stop shooting.

⑤ [RET] return video button

The return video signal from the VTR section can be monitored in the viewfinder only while this button is pushed.
 * The playback picture can be viewed in the viewfinder during this operation.

⑥ ZOOM servo control lever

To operate the servo zoom feature with this lever, set the ZOOM knob ⑫ to "S".

- Pressing the "W" section of this lever increases the angle of the lens for a wider shooting angle.
- Pressing the "T" section of this lever narrows the lens angle perspective for telephoto shots.
- Pushing harder changes the speed of the zoom.

2. CONTROLS, INDICATORS AND CONNECTORS

2-8 1.5-Inch Viewfinder (Optional)

[VF-P115B]

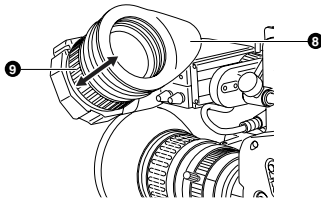
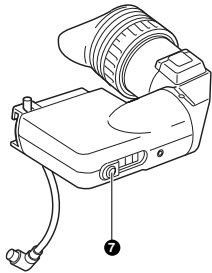
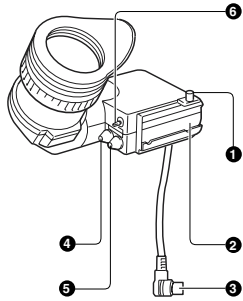

- 1 Stopper screw**
 This screw prevents the viewfinder from coming off the camera.
- 2 Mounting guide**
 To attach on the camera.
- 3 Connector**
 Connect to the camera.
- 4 [CONT] contrast adjustment**
 To adjust the contours of the viewfinder image.
- 5 [BRIGHT] brightness adjustment**
 To adjust the brightness of the viewfinder.
- 6 [TALLY] switch**
 Set this switch to OFF to prevent the tally light 7 from turning on and informing people that they are being recorded. However, the REC indicator lamp in the eyepiece will not turn off.
- 7 Tally light**
 Lights when recording is in progress. To prevent this light from coming on, set the tally switch 6 to OFF. Select the lighting method with the FRONT TALLY item on the OTHERS (2/2) menu screen.
 ⇨ See page 78.
- 8 Eyepiece**
 Ensures that ambient light does not reach the viewfinder screen or falls into the eye of the cameraman. The eyepiece can be opened to allow direct observation of the viewfinder screen.
- 9 Eyepiece focusing ring**
 Loosen this ring to move the eyepiece back or forth to adjust the diopter.
 ⇨ See "Attaching the Viewfinder" on page 30.

3. BASIC SYSTEM CONNECTIONS AND ADJUSTMENTS

3-1 Basic System

* For information on connection with the individual attachments, refer to the page explaining the respective connection methods.

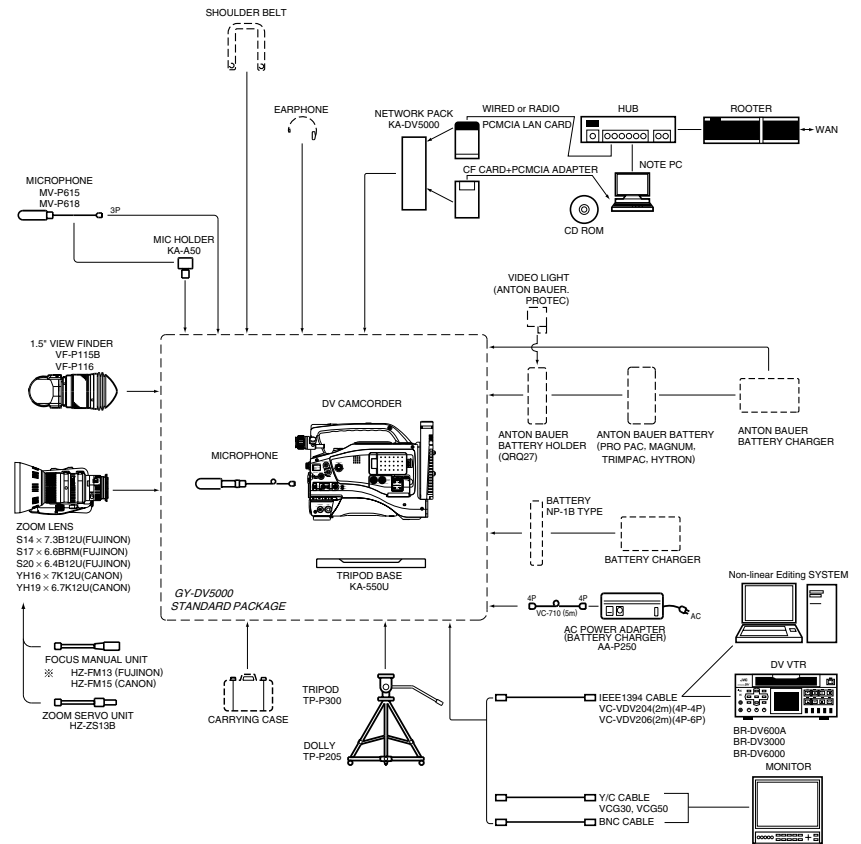

※ HZ-FM13 cannot be used with S14 × 7.3B12/U.

Please use the Focus Manual Unit (FMM-8, CHF-3, CFC-12-990) manufactured by Fujinon.

3. BASIC SYSTEM CONNECTIONS AND ADJUSTMENTS

3-2 Attaching the Zoom Lens

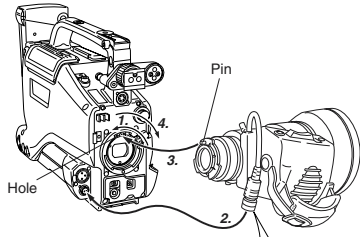

When unplugging the cable connector, first remove the lens itself. Then grasp this portion and pull out.

1. Loosen the mount ring.
2. Connect the cable connector.
3. Attach the lens with its pin aligned with the hole in the mount.
4. Tighten the mount ring.

CAUTION:

- Be sure to tighten the mount ring completely. Incomplete tightening may result in the lens dropping off or disturbed back focus.
- Set the GY-DV5000's power switch to "OFF" before the zoom lens is attached or detached.

3-3 Attaching the Viewfinder

By changing the position of the viewfinder mount base on the camera the viewfinder can be observed with either the left or the right eye.

When shipped from the factory, the viewfinder mount base is attached so that the viewfinder is mounted for right eye use. After the viewfinder has been attached, the viewfinder can be slid forward.

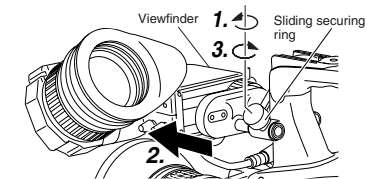
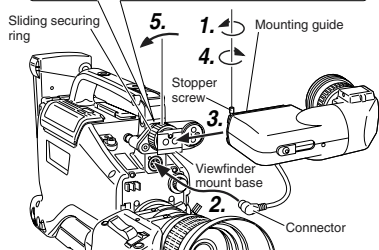
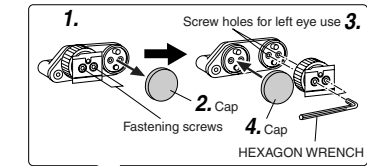

■ Observing the viewfinder with the left eye
Change the mounting position of the viewfinder mount base.

1. Loosen the two fastening screws of the viewfinder mount base with a hexagon wrench (Provided) and then remove the viewfinder mount base (including the sliding securing ring).
2. Remove the cap.
3. Mount the viewfinder mount base (including the sliding securing ring) at the screw holes for left eye use and tighten the screw with the hexagon wrench (Provided).
4. Attach the removed cap on the right-eye side.

■ Attaching the Viewfinder

1. Loosen the stopper screw.
2. Connect the cable connector.
3. Attach the viewfinder with its guide aligned with the shoe.
4. Tighten the stopper screw.
5. Tighten the sliding securing ring.
* Reverse the procedure to remove the viewfinder.

■ Sliding the viewfinder forward

1. Loosen the sliding securing ring.
2. Slide the viewfinder forward.
3. Tighten the sliding securing ring.

CAUTION:

- Set the GY-DV5000's power switch to "OFF" before the viewfinder is attached or detached.

3. BASIC SYSTEM CONNECTIONS AND ADJUSTMENTS

3-4 Attaching the Microphone (Provided)

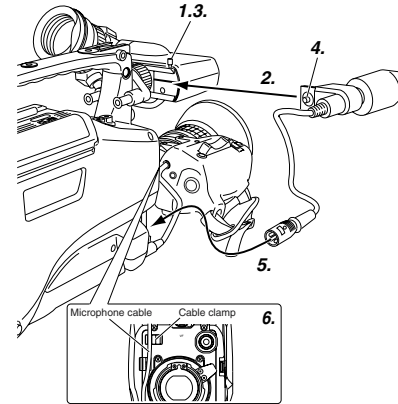

Connect the provided microphone to the viewfinder. The provided microphone is a phantom microphone.

1. Loosen the stopper screw on the viewfinder.
2. Attach the microphone to the attachment guide on the viewfinder as illustrated.
3. Confirm that there is no gap between the microphone and the viewfinder, and then tighten the stopper screw.
4. Tighten the screw on the microphone. The microphone should be firmly attached.
5. Connect the cable from the microphone to the FRONT AUDIO IN connector on the camera.
6. Secure the microphone cable using the cable clamp provided on the front side of the microphone holder.

MEMO:

When attaching the viewfinder for use with the left eye, the provided microphone cannot be attached. In this case, use the optional microphone holder KA-A50 and microphones MV-P615U/618U (phantom microphone).

3-5 Attaching the Microphone (Optional)

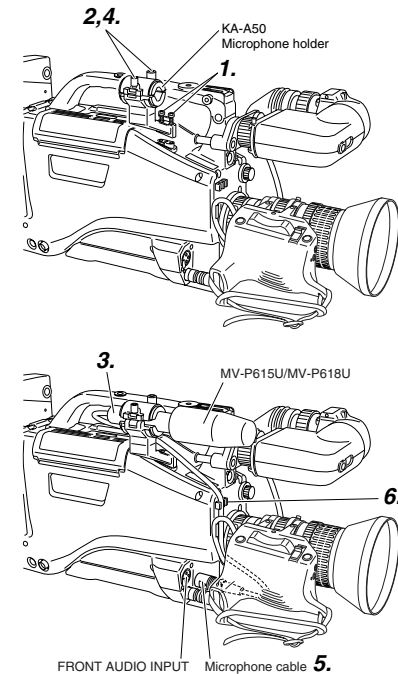

With the optional KA-A50 microphone holder, the optional microphones MV-P615U (phantom microphone) and MV-P618U (phantom microphone) can be used.

<Attaching the Microphone Using KA-A50>

1. Secure the microphone holder with 2 screws.
2. Turn the small knob located on the outer side of the microphone holder counterclockwise to loosen it, and loosen the large knob located on the inner side in the same way. Rotate the large knob fully counterclockwise to open the holder.
3. Attach the microphone to the microphone holder at the designated place so that the microphone does not interfere with the cassette cover.
4. Set the microphone holder so that the height is level, and tighten the inside and outside knobs to secure the microphone.
5. Connect the microphone cable to the FRONT AUDIO IN connector.
• When the microphone is connected to REAR AUDIO IN connector on the rear panel, set the CH-1 or CH-2 AUDIO input selector switch to REAR.
6. Secure the microphone cable using the cable clamp located on the front side of the microphone holder.
7. Make sure to perform the correct settings for use of a phantom microphone.
* See "FRONT/REAR AUDIO INPUT switch ①" on page 15.

CAUTION:

- When the light mounted on the camera is used at the same time, if the microphone in use has a long sound collecting section, the microphone's shadow may appear in the image.

3. BASIC SYSTEM CONNECTIONS AND ADJUSTMENTS

3-6 Attaching the Tripod Base (Provided)

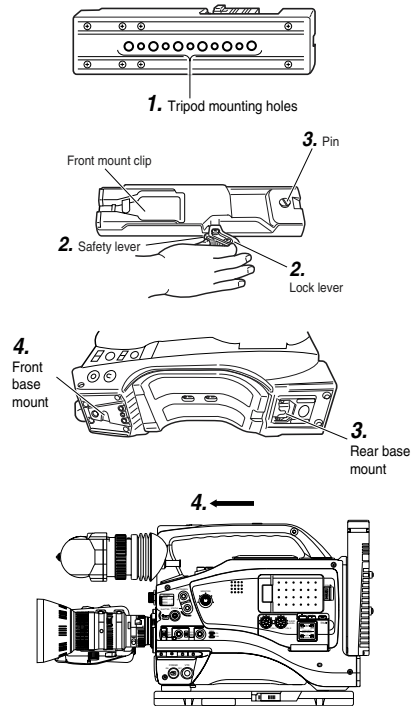

Use the provided KA-550U tripod base to place the camera on a tripod.

1. Attach the tripod base on the tripod by using the hole that balances the unit most optimally.
2. While pushing the safety lever, pull the lock lever toward the front until the front mount clip clicks into place.
3. Place the unit on the tripod base by aligning the rear base mount of the unit with the pin on the tripod base.
4. Push the unit from the upward direction and slide it toward the front so that the front base mount of the unit is locked by the front mount clip of the tripod base as it clicks into place.

CAUTION:

- The front base mount may be locked while the pin of the tripod base is not inserted into the hole on the rear base mount of the unit. Therefore, after mounting, make sure that these parts are engaged properly.
- When moving the unit mounted on a tripod, any impact or vibration should be avoided as this may cause the unit to become detached and to drop from the tripod. Be sure to remove the unit from the tripod before transporting it.

4. POWER SUPPLY

The GY-DV5000 is operable with AC power supply or battery pack.

4-1 AC Operation

Use the JVC AA-P250 AC power adapter (max. rated output 12.5 V DC, 3.5 A) as the AC power supply.

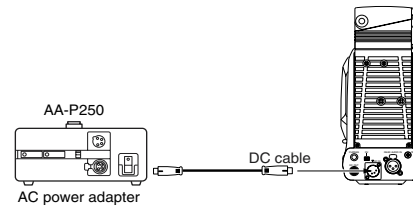

Do not use any power source with large fluctuations in the power source voltage, power sources generating noise, such as ripples or power sources with lower voltage.

1. After making sure that the power switches of the GY-DV5000 and of the AA-P250 are set to OFF, connect the DC cable from the AA-P250 to the DC IN connector of the GY-DV5000 as shown in the illustration.
2. Set the CHARGE/CAMERA switch of the AA-P250 to CAMERA.
3. Press the POWER switch of the GY-DV5000 to ON. Power is supplied to the VTR section and the camera.
* For details, read the instruction manual of the AA-P250.

MEMO:

Do not remove or connect the DC cable while recording is being performed.

4-2 Battery Pack Operation (Optional)

The GY-DV5000 can be operated with the following battery packs.

- Flat shape type battery pack
- Anton-Bauer battery pack
 - Propack 13/14 Series
 - Trimpack 13/14 Series
 - Magnum 13/14 Series
 - Compack 13/14 Series

* An Anton-Bauer battery pack cannot be connected directly to the GY-DV5000. It is necessary to mount the optional battery holder.
Battery holder: Anton-Bauer QRQ27
For details on how to mount the battery holder, see page 35.

- When the DC cable is connected to the DC IN connector, the power supply from the battery pack is interrupted and the power starts to be supplied through the DC IN connector.
- Do not connect or disconnect the DC cable while operating with a battery pack.
The following symptoms may occur if the DC cable is connected or disconnected while operating with a battery pack.
 - The power is cut off for a moment when the DC cable is disconnected.
 - Noise to the video and audio signals occurs. Audio signal are muted.
- When operation is continued with DC input after the battery pack capacity has been used up, set the POWER switch to OFF after the DC power is applied. Then switch ON again.
- If the GY-DV5000 is left with the battery pack attached, a small amount of power is consumed even if the POWER switch on the GY-DV5000 is set to OFF. Remove the battery pack when the GY-DV5000 is not going to be used.

4. POWER SUPPLY

4-2 Battery Pack Operation (Optional) (Cont'd)

Using a Flat Shape Type Battery Pack (optional)

Attaching a Flat Shape Type Battery Pack

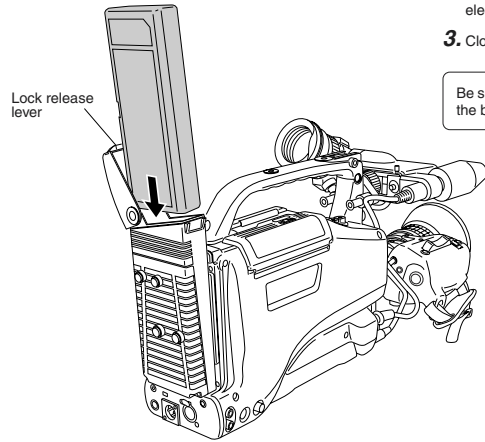

1. Open the battery case cover while pushing the lock release lever.
2. Insert the battery pack into the battery case with its electrodes facing the unit.
3. Close the battery case cover.

Be sure to set the POWER switch to OFF before replacing the battery pack.

4. POWER SUPPLY

Using an Anton-Bauer Battery Pack

To use an Anton-Bauer battery pack (Propack 13/14, Trimpack 13/14, Magnum 13/14, Compack 13/14 Series), it is necessary to detach the battery case from the GY-DV5000 and replace it with the Anton-Bauer battery holder. Use the following battery holder.
 • Battery holder: Anton-Bauer QRQ27

Detaching the Battery Case From the GY-DV5000 and Attaching The Anton-Bauer Battery

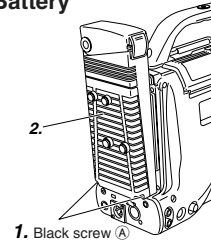

1. Remove the two black screws (A) on the battery case.
2. Remove the lower half of the battery case cover in the downward direction.

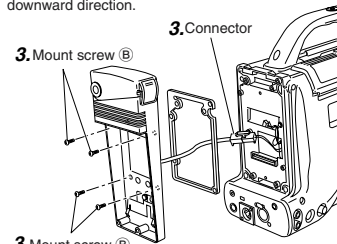

3. To remove the battery case, remove the four screws (B) fixing the battery case and the connector connecting the battery case to this unit.

Attaching the Anton-Bauer Battery Holder

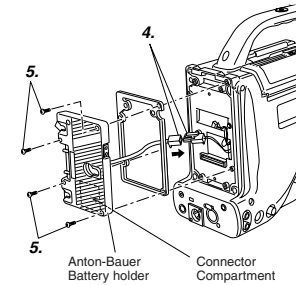

4. Connect the connectors protruding from the GY-DV5000 with the connectors on the battery holder.

CAUTION:

Following connection of the connectors, insert them into the connector compartment. Take care not to pinch the wires. This could result in damage.

5. Secure the battery holder to the GY-DV5000 with the four mount screws provided with the battery holder.

Attaching and Detaching an Anton-Bauer Battery Pack

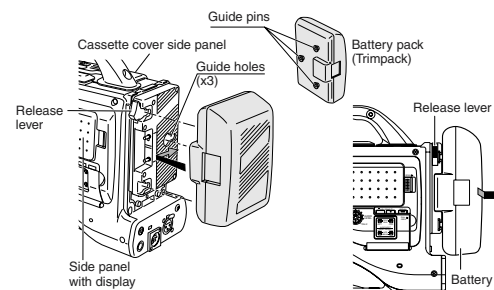

Attaching the Battery Pack

1. Align the 3 guide pins of the battery pack with the guide holes on the battery holder, and push straight to insert the battery pack. The battery cannot be attached properly if the guide pins are not inserted straight.
2. Slide the battery pack toward the side panel where the cassette cover is located until it clicks. Now the battery pack has been attached.

Detaching the Battery Pack

- While pushing the release lever, slide the battery pack toward the side panel where the LCD display is located, then pull the battery pack outward to remove.

4. POWER SUPPLY

4-2 Battery Pack Operation (Optional) (Cont'd)

REMAINING BATTERY POWER DISPLAY

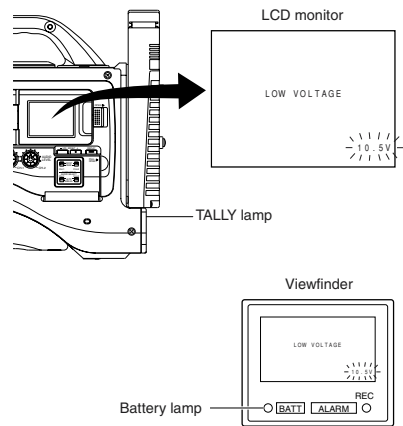

To display the remaining battery power accurately, set the BATTERY TYPE item on the OTHERS (2/2) menu screen in accordance with the type of the battery pack in use.
* See "BATTERY TYPE" on page 78.

When the remaining battery power is nearly exhausted, the following warnings will be generated.

- Viewfinder screen or LCD monitor
 - When a Status screen is displayed (excluding the Status 2 screen in the Camera mode)
 - Voltage indication: Blinks
 - Alarm indication: LOW VOLTAGE displayed.
 - Viewfinder lamps
 - BATT lamp and TALLY lamp: Blinks
 - BACK TALLY lamp on camera: Blinks
 - Monitoring loudspeaker and PHONES jack: Alarm sound

After the remaining battery power warnings appear, the GY-DV5000 automatically stops operation if the battery power operation is continued.

Operating Time with Battery Pack

When the VF-P115B is used as the viewfinder and a fully charged battery pack is attached, the approximate continuous operating time is as follows:

Battery Pack	Continuous Operating Time (at 25 °C)
NP-1B	60 minutes
Magnum 14	130 minutes
NP-L40	80 minutes

- Battery operating time may differ depending on the age of the battery, charging conditions and the operating environment, etc. Use the values in the table on the left for approximate reference times.
- Operating time is reduced in areas with a cold environment.
- Operating time is reduced when the power zoom lens and LCD are used frequently.

PRECAUTIONS FOR THE BATTERY PACK

- When the battery pack is not in use, it must be stored in a cool, dry place.
Do not leave the battery pack in a place where it might be subject to a high temperature (under direct sunlight in a car, etc.), this could cause leakage of the fluid or shorten service life.
- When the terminal section of the battery pack gets dirty, the operating time will be shortened.
- If the operating time becomes greatly reduced even immediately after recharging, the service life of the battery pack is nearly finished. Purchase a new battery pack.

Recharging

- Recharge the battery pack after completely discharging it. Repeated recharging with residual charge remaining could result in reduced battery capacity.
- If the battery capacity is reduced by repeating incomplete recharging, or recharging without discharging, once discharge the battery pack completely, then recharge it to restore the battery capacity.
- If the battery pack is recharged with its internal temperature raised immediately after use, recharging may not be performed completely.

5. PREPARATIONS

5-1 Turning the Power ON

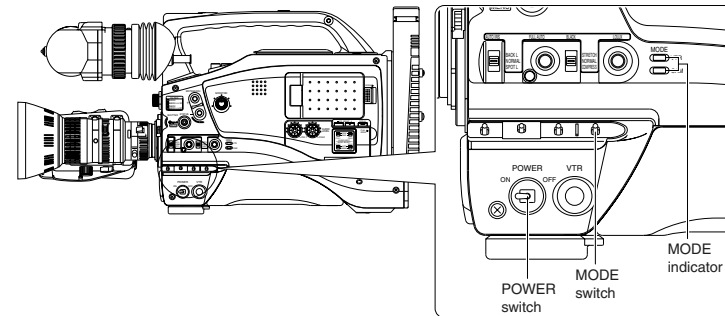

1. Set the POWER switch to ON.

The unit turns on in Camera mode.

- The operation differs according to whether the unit is in the Camera mode or in the VTR mode.

When the MODE switch is pressed upward, the mode is changed.

The Camera indicator or VTR indicator comes on in accordance with the selected mode.

Mode	Operation
Camera mode	The GY-DV5000 enters the record mode. The camera image is displayed in the viewfinder or on the LCD monitor. When a recordable videocassette is loaded, the GY-DV5000 enters the record-standby mode automatically. "STBY" is displayed in the VTR operation mode indication area of the LCD monitor or in the viewfinder. In this condition, press the VTR trigger button to start recording. * Playback is also possible in the Camera mode. Playback operation becomes possible when the STOP button is pressed to set the VTR operation mode indicator to indicate STOP.
VTR mode	The GY-DV5000 enters the VTR playback mode. The camera image will not be displayed in the viewfinder or on the LCD monitor. When a videocassette is loaded, the GY-DV5000 enters the stop mode. "STOP" is displayed in the VTR operation mode indication area of the LCD monitor or in the viewfinder.

Turning the Power OFF

1. Place the GY-DV5000 in the record-standby or STOP mode.

2. Set the POWER switch to OFF.

3. Remove the battery pack or the power supply to the DC IN connector. (When the camera is not going to be used for a longer period.)

CAUTION:

- Do not set the POWER switch to OFF while recording is taking place. Confirm that the STBY or STOP indication is shown in the VTR operation mode indication area before the power is turned off. Should the POWER switch accidentally be set to OFF during a recording, wait at least 5 seconds before turning the power on again.
- Always set the POWER switch to OFF before disconnecting the power supply. Do not turn the battery pack or AC power supply OFF while the POWER switch on the camera is still set to ON.

5. PREPARATIONS

5-2 Cassette Loading and Unloading

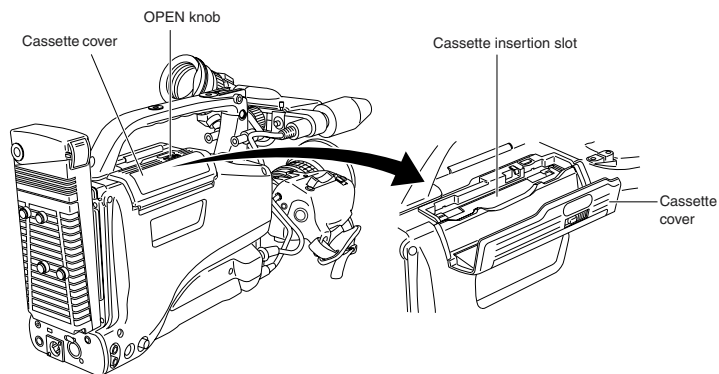

- A cassette cannot be loaded or unloaded while the GY-DV5000 is in POWER OFF mode.
- Use a standard DV videocassette or a MiniDV videocassette.
- Press at the center portion of the cassette back and insert the cassette tape straight into the slot.

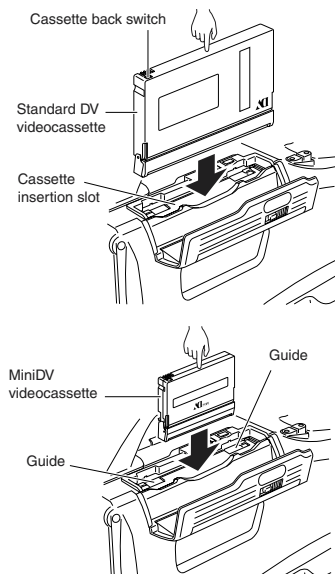

Loading the Cassette

1. Set the POWER switch to ON.
2. Slide the OPEN knob to the side to open the cassette cover.
3. Insert a videocassette into the cassette slot after removing the tape slack.
 - Insert a standard DV videocassette along the cassette insertion slot by pressing at the center portion of the cassette back.
 - Insert a MiniDV videocassette between the left and right side guides on the cassette insertion slot. The tape window should face outward and the cassette back switch should be up. Press on the center of the back of the videocassette and ensure that it is fully inserted.
4. After the tape is completely loaded, slowly close the cassette cover by pushing it in all the way.
 - The status when the tape is loaded differs with the mode of the GY-DV5000 (Camera mode or VTR mode) and the condition of the switch on the back of the cassette as show below.

Cassette Back Switch		
	REC	SAVE
Camera	Record-standby mode	STOP mode. REC INHIBIT is displayed on the LCD monitor and in the viewfinder.
VTR	STOP mode	

Recording can be started by pressing the VTR trigger button from the record-standby mode.

CAUTION:

Do not attempt to push the cassette all the way in while the cassette is being pulled in automatically. This could result in damage.

5. PREPARATIONS

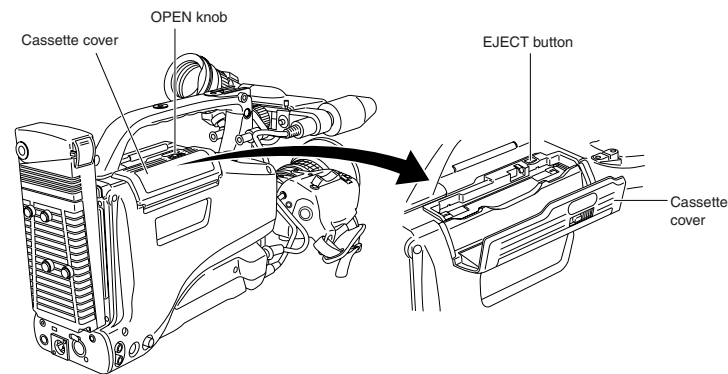

Unloading the Cassette

1. Set the POWER switch to ON.
2. Slide the OPEN knob to the side to open the cassette cover.
3. Press the EJECT button.
 - Tape ejection starts.
4. Take out the videocassette.
5. Close the cassette cover.

MEMO:

It takes a few seconds before the cassette is ejected after the EJECT button is pressed. Do not close the cassette cover during the eject operation.

CAUTION:

- Do not leave the unit for a long period with the cassette cover open. Dirt or other foreign objects may enter the VCR section and cause malfunction.
- Do not touch the cassette insertion slot or cassette during the eject operation. This could result in damage.

5. PREPARATIONS

5-3 Viewing the LCD Monitor

The LCD monitor's orientation, angle, and brightness, etc. can be changed.

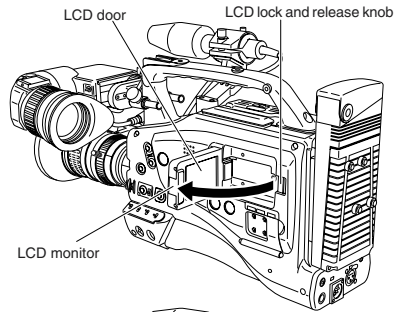

Opening the LCD monitor

Slide the LCD lock and release knob toward the rear section to open the LCD monitor. Grasp the upper and lower edges of the LCD monitor to open it easily.

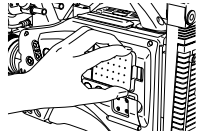

Changing the orientation and angle of the LCD monitor

- With the LCD door in the open position, turn the LCD door. The LCD door can be turned 180 degrees upward and 90 degrees downward.
- If the LCD door is turned 180 degrees upward and housed in the camera body, the LCD monitor can be viewed from outside while it remains housed in the camera body.

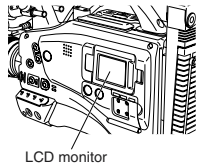
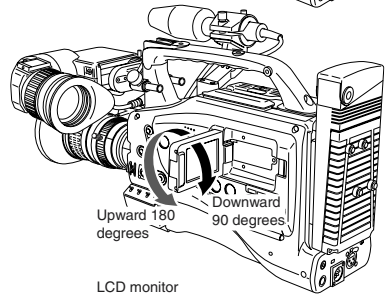

Displaying on the LCD monitor

- When the DISPLAY button is pressed for a long time, the display on the LCD monitor is switched between ON and OFF.
- Each time the DISPLAY button is briefly pressed while the LCD monitor is used for display, the contents change as follows.

Image only → Characters displayed magnified
 Image and Characters ←

Adjusting the LCD monitor

- Brightness of screen : Adjust with the LCD BRIGHT +/- button.
- Color saturation : Adjust the LCD COLOR item on the LCD/VF (2/2) menu.
- Contrast of screen : Adjust the LCD PEAKING item on the LCD/VF (2/2) menu.

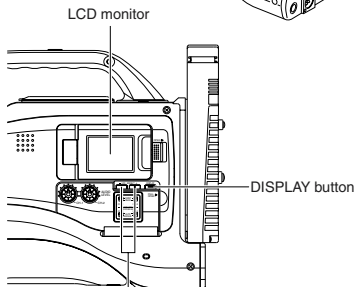

LCD BRIGHT +/- button

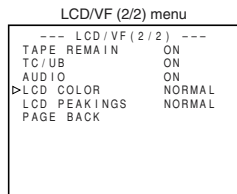

5. PREPARATIONS

5-4 Setting, Displaying and Recording the Date and Time

The date and time of the built-in clock should be set. Powered by the built-in backup battery the set date and time data continue to count even when the power is switched off.

- The set date and time data are displayed on the LCD monitor or in the viewfinder and recorded on the tape in accordance with the settings made on the menu screen.

Setting the Date and Time

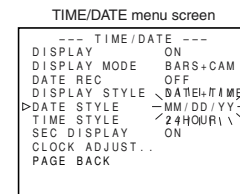
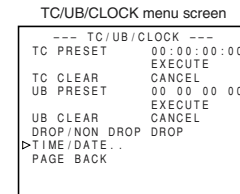
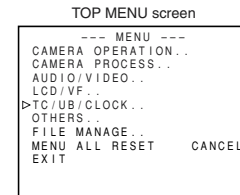
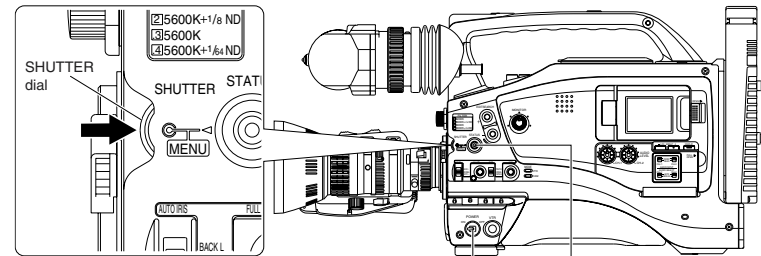

POWER switch STATUS button

- The date and time are set on the CLOCK ADJUST menu screen. When setting while observing on a monitor connected to the VIDEO OUT or Y/C OUT connector, set the OUTPUT CHAR. item on the OTHERS (1/2) menu screen to ON.

1. Set the POWER switch to ON.
2. Press the STATUS button for 1 second or longer to display the TOP MENU screen.
3. Rotate the SHUTTER dial to align the cursor (▶) with the TC/UB/CLOCK item, and then press the SHUTTER dial in the direction of the camera body.
 - The TC/UB/CLOCK menu screen appears.
4. Rotate the SHUTTER dial to align the cursor (▶) with the TIME/DATE item, and then press the SHUTTER dial.
 - The TIME/DATE menu screen appears.
5. Make settings on the TIME/DATE menu screen. (This includes display style, etc.)
 - DATE STYLE** : Selects the style for displaying the date.
 - YY/MM/DD (Year, month, day)
 - MM/DD/YY (Month, day, year)
 - DD/MM/YY (Day, month, year)
 - TIME STYLE** : The time can be set to display as a 12-hour or 24-hour clock system.
 - SEC DISPLAY** : To select whether or not indication of seconds should be displayed on the screen.

- ① Rotate the SHUTTER dial to align the cursor (▶) with the item to be set, and then press the SHUTTER dial.
 - The setting area of the selected item starts blinking.
- ② Rotate the SHUTTER dial to change the setting, and then press the SHUTTER dial.
 - The setting area stops blinking and the setting is entered.

MEMO:

The TIME STYLE, SEC DISPLAY and DATA STYLE items can also be set and changed after the date and time have been set.

5. PREPARATIONS

5-4 Setting, Displaying and Recording the Date and Time (Cont'd)

TIME/DATE menu screen

```

--- TIME/DATE ---
DISPLAY      ON
DISPLAY MODE BARS+CAM
DATE REC     OFF
DISPLAY STYLE DATE+TIME
DATE STYLE   MM/DD/YY
TIME STYLE   24HOUR
SEC DISPLAY  ON
▷CLOCK ADJUST...
PAGE BACK
    
```

CLOCK ADJUST menu screen

DATE (Year/Month/Day)

```

--- CLOCK ADJUST ---
▷DATE (MM/DD/YY) 12+12+02
TIME             09:30
PAGE BACK
    
```

Time (Hour:Min)

6. Display the screen for setting the date and time. Rotate the SHUTTER dial to align the cursor (▶) with the CLOCK ADJUST item, and then press the SHUTTER dial.
 - The CLOCK ADJUST screen appears.
7. Set the date and time.

The blinking digit is the one to be set.

 - ① When the SHUTTER dial is pressed, the blinking digit moves to the next digit.
 - ② When the SHUTTER dial is rotated, the value of the blinking digit changes. When the SHUTTER dial is rotated upward, the value becomes higher. When rotated downward, the value becomes smaller.
 - ③ Repeat the procedure described in ① and ② above to set the month, day, year, hours, minutes. The digits indicating seconds cannot be set.
 - ④ Press the SHUTTER dial in sync with a time signal to enter the date and time precisely.
8. When all the settings are completed, rotate the SHUTTER dial to align the cursor with the PAGE BACK item, and then press the SHUTTER dial.
 - The TIME/DATE menu screen returns.
9. To return to the normal screen, use either of the following methods.
 - Press the STATUS button or
 - Return to the TOP MENU screen and then select the EXIT item from the TOP MENU screen before pressing the SHUTTER dial.

5. PREPARATIONS

Displaying the Time and Date on the Screen

TC/UB/CLOCK menu screen

```

--- TC/UB/CLOCK ---
TC PRESET    00:00:00:00
              EXECUTE
TC CLEAR     CANCEL
UB PRESET    00 00 00 00
              EXECUTE
UB CLEAR     CANCEL
DROP/NON DROP
▷TIME/DATE...
PAGE BACK
    
```

TIME/DATE menu screen

```

--- TIME/DATE ---
▷DISPLAY      ON
DISPLAY MODE  BARS+CAM
DATE REC     OFF
DISPLAY STYLE DATE+TIME
DATE STYLE   MM/DD/YY
TIME STYLE   24HOUR
SEC DISPLAY  ON
CLOCK ADJUST...
PAGE BACK
    
```

```

FAS
-SGB
FAW
I
SD
S
12.2V
01/02/03 AMO 1:23:45
    
```

Date Time

Whether or not the time and date should be displayed on the screen and how to display them are set on the TIME/DATE menu screen.

1. Display the TIME/DATE menu screen.
 - ① Select the TC/UB/CLOCK item on the TOP MENU screen.
 - ② Select the TIME/DATE item on the TC/UB/CLOCK menu screen.
 2. Set the TIME/DATE menu screen.
 - **DISPLAY item** : Sets whether or not date and time should be displayed. Set to ON to display the indications.
 - **DISPLAY MODE item** : Sets the video output mode in which date and time should be displayed.
 - BARS** : Displayed when the OUTPUT switch on the side section is set to BARS.
 - CAM** : Displayed when the OUTPUT switch on the side section is set to CAM.
 - **DISPLAY STYLE** : Sets the style in which the date and time are displayed.
 - DATE + TIME** : Date and time are displayed.
 - DATE** : Date only is displayed.
 - TIME** : Time only is displayed.
- **Display of date and time in the various operation modes.**
- In Camera mode** : The date and time of the internal clock are displayed.
 - In VTR playback mode** : The date and time recorded on the tape are displayed.
 - In VTR stop mode** : The date and time of the internal clock are displayed.
 - During DV signal input** : The date and time from the DV connector are displayed.

Recording the Date and Time Data

TIME/DATE menu screen

```

--- TIME/DATE ---
DISPLAY      ON
DISPLAY MODE  BARS+CAM
▷DATE REC     BARS+CAM
DISPLAY STYLE DATE+TIME
DATE STYLE   MM/DD/YY
TIME STYLE   24HOUR
SEC DISPLAY  ON
CLOCK ADJUST...
PAGE BACK
    
```

To record the date and time data during shooting, make the menu settings described below. When the DATE REC item on the TIME/DATE menu screen is set to "BARS" or "BARS+CAM", the screen size will be fixed at an aspect ratio of 4:3.

- **Setting the TIME/DATE menu**
 - **DISPLAY item** : Set to ON.
 - **DATE REC item** : Select the video mode in which date and time data should be recorded.
 - BARS** : Date and time data are recorded only when color bars are output.
 - BARS+CAM** : Date and time data are recorded when color bars and camera image are output.
 - OFF** : Date and time data are not recorded.

MEMO:
DATE REC cannot be set during recording.

5. PREPARATIONS

5-5 Charging the Built-in Battery

The built-in, rechargeable backup battery retains the date and time and the time code data. The built-in battery is constantly being charge whenever the GY-DV5000 is connected to a power supply, but it gradually discharges while the GY-DV5000 is disconnected from a power supply. The battery will be fully discharged when the GY-DV5000 is not used for about three months, in which case the set date and time and time code data are reset. In this case, recharge the built-in battery and then set the date and time and time code data again.

However, it is possible to use the GY-DV5000 even if the built-in battery is discharged but the date and time and time code data cannot be recorded.

■ How to charge

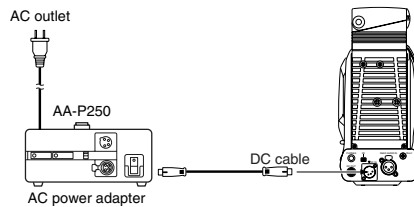

1. Connect the provided AC adapter AA-P250 to the GY-DV5000 and an AC outlet or mount a charged battery on the GY-DV5000.
2. Set the POWER switch on the GY-DV5000 to "OFF" or "ON" (charging takes places with the POWER switch set to either of the positions.)
3. Leave the equipment in this condition for about 4 hours.
 - The built-in battery will remain charged for about 3 months after being charged for about 4 hours.

6. SETTING AND ADJUSTMENTS BEFORE SHOOTING

6-1 Camera Settings

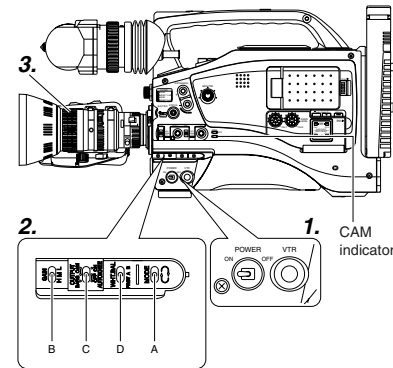

1. POWER SUPPLY

- ① First place a charged battery pack in the battery case on the rear section of the unit. If battery pack is not used, connect DC power to the DC INPUT connector on the rear section of the unit using the AC power adapter (AA-P250) to supply DC 12 V current.
- ② Set the POWER switch to ON.

2. SWITCH positions

- A. MODE switch: Camera mode (CAM indicator should be on).
- B. [GAIN] switch: Set to L. The L position is always 0 dB.
- C. [OUTPUT] switch: Set to CAM-AUTO KNEE OFF.
- D. [WHT. BAL] (Auto White Balance) switch: Set to A or B.

3. Set the lens' iris mode switch to "A" (AUTO IRIS side)

4. Choose the proper color temperature conversion filter.

	FILTER	Suitable Location
1	3200K	Indoors, dark outdoors
2	5600K+1/8ND	Outdoors under clear sky
3	5600K	Outdoors
4	5600K+1/64ND	Outdoors under clear sky

5. Using the SHUTTER dial, set the shutter speed to OFF (1/60).

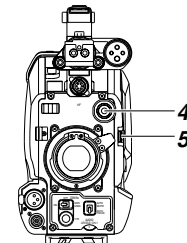

6-2 Screen Size (4:3/LETTER) Mode Selection

The screen size of recorded images can be selected with the ASPECT RATIO item on the CAMERA OPERATION menu screen. [☞] See page 69.

- To record using the standard screen, set ASPECT RATIO to 4:3.
- When ASPECT RATIO is set to LETTER, the image is recorded in a 16:9 aspect ratio with the upper and lower parts of the image cut. In this case, the viewfinder screen or LCD will show the 16:9 aspect ratio image with the upper and lower parts of the image cut.

MEMO:

- The safety zone of the standard screen and the 16:9 screen can be displayed in the viewfinder or LCD by setting the SAFETY ZONE item on the LCD/VF (1/2) menu screen. [☞] See page 73.
- When ASPECT RATIO is set to LETTER, 16:9 aspect ratio distinction ID signal is output from the Y/C OUT terminal.
- When setting DATE REC in the TIME/DATE menu screen to "BARS" or "BARS+CAM", the screen size will be fixed at an aspect ratio of 4:3.

6. SETTING AND ADJUSTMENTS BEFORE SHOOTING

6-3 Viewfinder Adjustment

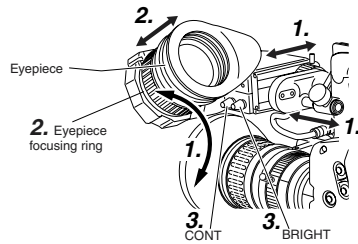

1. Adjust the position and angle of the viewfinder.
2. Diopter adjustment
Rotate the eyepiece focusing ring until the viewfinder screen image is clearly visible.
3. Brightness and contrast adjustment
When the ambient brightness changes, etc., the brightness and contrast of the viewfinder screen can be adjusted with the BRIGHT and CONT controls.

MEMO:

The screen size of the viewfinder can be changed by selecting the desired size with the ASPECT RATIO item on the CAMERA OPERATION menu screen (4:3 or LETTER).

6-4 External Monitor Adjustment

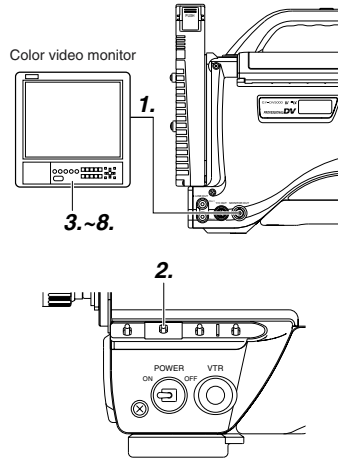

Display the camera built-in color bar signal on the video monitor and adjust the colors, contrast and brightness.

1. Connect a color video monitor to the MONITOR OUT connector of the GY-DV5000.
2. Set the COLOR BARS/CAMERA/AUTO KNEE switch to BARS to output the color bar signal (SMTPE type color bars).
3. Set the monitor's BLUE CHECK function to ON while the color bars are being displayed so that the screen turns entirely blue and the color bars become blue stripes.
4. Adjust the CHROMA control of the monitor so that there is no difference in brightness between the color bars ① and ⑧, ⑦ and ⑭.
5. With the BLUE CHECK function ON, adjust the PHASE control of the monitor so that there is no difference in brightness between the color bars ③ and ⑩, ⑤ and ⑫.
6. If the phase control adjustment above causes a difference in brightness between the color bars ① and ⑧, ⑦ and ⑭, start again from the CHROMA control adjustment in step 4.
7. Set the monitor's BLUE CHECK function to OFF to switch the monitor back to the standard screen (R, G and B will all appear).
8. Use the monitor's brightness control to adjust so that the color bars ⑮ and ⑯ disappear but ⑰ is visible.

■ SMTPE type color bars

White ①	Yellow ②	Cyan ③	Green ④	Magenta ⑤	Red ⑥	Blue ⑦
Blue ⑧	Black ⑨	Magenta ⑩	Black ⑪	Cyan ⑫	Black ⑬	White ⑭
Black ⑮	White ⑯	Black ⑰				

6. SETTING AND ADJUSTMENTS BEFORE SHOOTING

6-5 Back Focus Adjustment

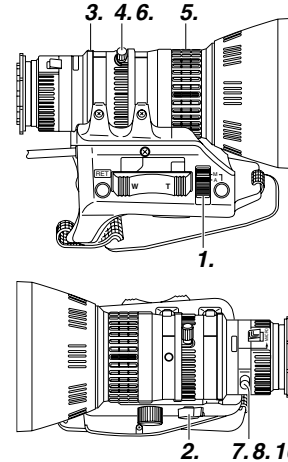

It is only necessary to perform this when the lens is attached for the first time or when focusing is not correct in both the telephoto and wide-angle positions.

It is easier to adjust back focus when the subject is more than 3 meters from the camera.
The optimal subject for this adjustment is a Siemens star chart.

1. Set the IRIS mode switch to M (Manual).
2. Set the zoom mode to M (Manual).
3. Open the iris by turning the iris ring. If the illumination is too strong, reduce it or move to a darker place.
4. Turn the zoom lever until the lens is at the maximum telephoto position.
5. Bring the subject into focus.
6. Set the lens to maximum wide-angle.
7. Loosen the back focus ring retaining knob.
8. View the same subject and adjust the back focus ring for the best possible focus.
9. Repeat steps 4. through 8. about three times for fine adjustment until the subject remains in focus in both the telephoto position and the wide-angle position.
10. Tighten the back focus ring retaining knob to secure the ring.

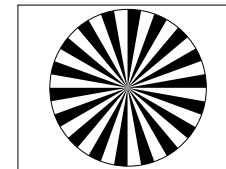

Siemens star chart

MEMO:

ACCU FOCUS can also be used in the above step 3.

6. SETTING AND ADJUSTMENTS BEFORE SHOOTING

6-6 White Balance Adjustment

Since the color of light (color temperature) varies depending on the light source, it is necessary to re-adjust the white balance when the main light source illuminating the subject changes.

Note

When a subject illuminated by a halogen lamp with a color temperature of 3,200K is shot while the color temperature conversion filter setting is set to 5,600K, 5,600K+1/8 ND, or 5,600K+1/64 ND, a proper white balance adjustment and (FAW) Full Time Auto White balance may not be accomplishable. In this case, change the color temperature conversion filter setting to 3,200K and then carry out the white balance adjustment and (FAW) again.

- Do not adjust using any highly reflective objects, such as metal, etc., as this may result in improper white balance adjustment.

WHITE BALANCE ADJUSTMENT

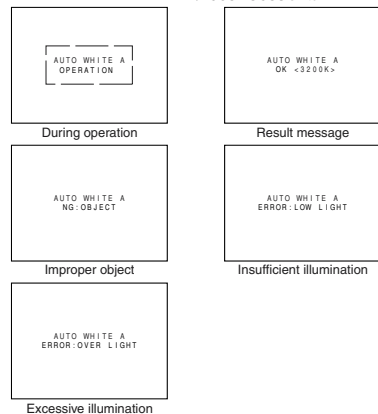
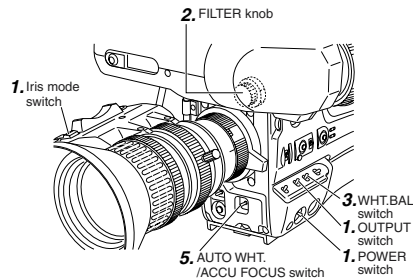

FULL-TIME AUTO WHITE BALANCE (FAW)

The FAW function adjusts the white balance value automatically as the lighting condition changes.

This mode is convenient when you have no time to adjust the white balance or when the camera is moved frequently in and out of places under different lighting conditions.

Setting procedure

The FAW function can be activated with the FAW item on the CAMERA OPERATION menu screen. The FAW function can be allocated to one of the white balance switching switches A, B, or PRESET.

☞ See "CAMERA OPERATION menu screen" on page 69.

Two kinds of white balance adjustment results can be stored in memories AUTO1 and AUTO2.

Adjustment procedure

- Set the following switches.
 - Set the POWER switch to ON.
 - Set the OUTPUT switch to CAM-AUTO KNEE.
 - Set the IRIS mode switch of the lens to A (Auto).
- Set the FILTER knob according to the current lighting.
- Set the WHT.BAL switch to A or B.
- Place a white object near the centre of the screen under the same lighting conditions as the target subject and zoom in to fill the screen with white.
- Tilt the AUTO WHT./ACCU FOCUS switch upward (to AUTO WHITE) once and release it. "AUTO WHITE A, B OPERATION" is displayed in the viewfinder while the auto white balance adjustment circuit operates. When correct white balance is obtained, the approximate color temperature is displayed together with "AUTO WHITE A, B OK" for about 5 seconds.

Error messages

If the adjustment ends abnormally, an error message, as described below, blinks for about 5 seconds.

- NG: OBJECT (Improper object)**
Displayed when there is not enough white color on an object or the color temperature is not suitable. Replace the color temperature conversion filter or use another white object and re-adjust the white balance.
- ERROR: LOW LIGHT (Insufficient illumination)**
Displayed when the illumination is dim. Increase the illumination and then re-adjust the white balance.
- ERROR: OVER LIGHT (Excessive illumination)**
Displayed when the light is excessively bright. Decrease the illumination and then re-adjust the white balance.

CAUTION:

- The FAW (Full-time Auto White balance) function cannot provide optimum white balance with a subject outside the FAW adjustment range, for example when it contains only a single color or not enough white color.
- The accuracy of the FAW (Full-time Auto White balance) is inferior to that of the manual white balance.
- When the power is turned on with the FAW mode selected, it takes about 10 seconds for the FAW adjustment to be completed. Do not shoot within this interval.

6. SETTING AND ADJUSTMENTS BEFORE SHOOTING

6-7 Audio Input Signal Selection

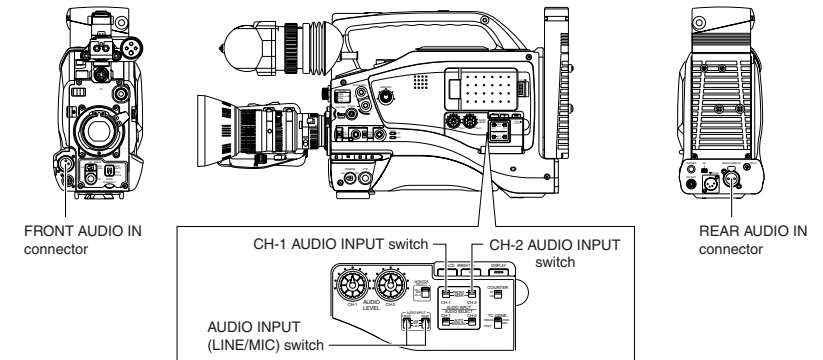

The GY-DV5000 is provided with the FRONT AUDIO IN connector and the REAR AUDIO IN connector for audio input. Two channels of sound can be recorded on the tape in digital PCM format. Using the AUDIO INPUT switch, select for each channel (CH1 and CH2) whether the sound to be recorded should be the sound from the FRONT AUDIO IN connector or the sound from the REAR AUDIO IN connector.

Selecting the CH-1 channel input sound

Make the selection using the CH-1 AUDIO INPUT switch.

FRONT : The sound from the FRONT AUDIO IN connector is recorded on the CH-1 channel.

REAR : The sound from the REAR AUDIO IN connector is recorded on the CH-1 channel.

Selecting the CH-2 channel input sound

Make the selection using the CH-2 AUDIO INPUT switch.

FRONT : The sound from the FRONT AUDIO IN connector is recorded on the CH-2 channel.

REAR : The sound from the REAR AUDIO IN connector is recorded on the CH-2 channel.

Selecting the FRONT AUDIO IN connector and REAR AUDIO IN connector

Select the sound to be input to the AUDIO INPUT connector using the AUDIO INPUT (LINE/MIC) switch. The setting is made individually for both the FRONT AUDIO IN connector and the REAR AUDIO IN connector.

LINE : Set to this position when connected to audio equipment, etc.

The reference input level is +4 dBs.

MIC : Set to this position when using a monaural microphone.

The reference input level is -60 dBs.

+48 V : Set to this position when a microphone (phantom microphone) requiring +48 V DC power supply is connected.

CAUTION:
Before connecting a component that does not require +48 V power supply, make sure that the AUDIO INPUT (LINE/MIC) switch is not set to +48 V. Neglecting this could cause damage to the connected component.

6. SETTING AND ADJUSTMENTS BEFORE SHOOTING

6-8 Recording Level Adjustment

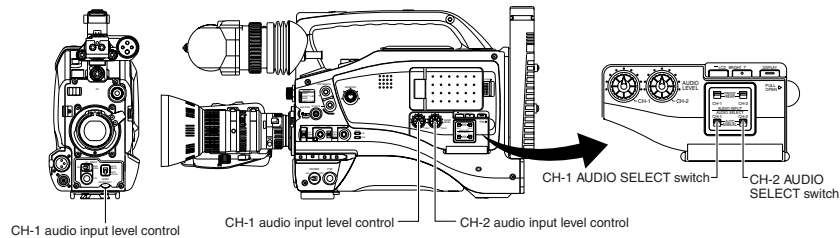

For each audio channel, use the AUDIO SELECT switches to select whether the audio level adjustment should be set to AUTO mode or MANUAL mode.

- **When set to AUTO** : Audio input level is fixed. In this mode, the audio input level control does not function.
- **When set to MANUAL**: Audio input level can be adjusted using the audio input level controls for each audio input. (The AUTO mode is selected in the Full Auto shooting mode.)

MEMO:

The reference level for audio recorded on the tape can be set with the AUDIO REF. LEVEL item on the AUDIO/VIDEO menu screen. (-20 dB or -12 dB). The level will change for both CH1 and CH2.

■ Adjusting the audio input level control on the front section

The audio input level control on the front section only affects the CH-1 channel sound.

To use the audio input level control on the front section, make the following settings.

- Set the CH-1 AUDIO SELECT switch to MANUAL.
- Set the CH-1 FRONT VR. item on the AUDIO/VIDEO menu screen to ENABLE.

MEMO:

The audio input level controls on the side section work regardless of the setting of CH-1 FRONT VR. item on the AUDIO/VIDEO menu screen.

The audio input level can be adjusted manually when the GY-DV5000 is in the record, record-standby or stop mode.

1. Set the AUDIO SELECT switch of the channel whose audio level that you want to adjust manually to MANUAL.
2. Rotate the audio input level control corresponding to the audio input level to be adjusted.
 - Adjust so that the peak level does not exceed the -3dB point when a loud sound is input.

■ Using the audio input level control on the front section

- 1 Set the audio input level control on the front section to maximum (10) position.
- 2 Initially, adjust the audio input level using the CH-1 audio input level control on the side.
- 3 If a loud sound is input during recording, use the audio input level control on the front section to lower the audio input level.

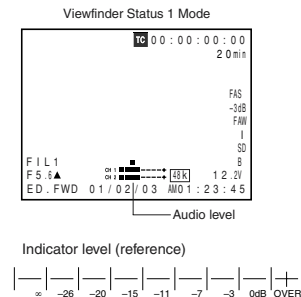

CAUTION:

- When the AUDIO INPUT LINE/MIC switch is set to MIC, be sure to check that the microphone is connected to the AUDIO INPUT connector. If the microphone is not connected, increasing the audio level could cause noise from the input connector to be recorded on the tape. When the microphone is not connected to the AUDIO INPUT connector, set the AUDIO INPUT LINE/MIC switch to LINE or turn down the audio level control.
- In the Full Auto shooting mode, the audio level volume cannot be adjusted with the audio level controls on the front and side sections.

6. SETTING AND ADJUSTMENTS BEFORE SHOOTING

6-9 Monitoring Audio during Recording

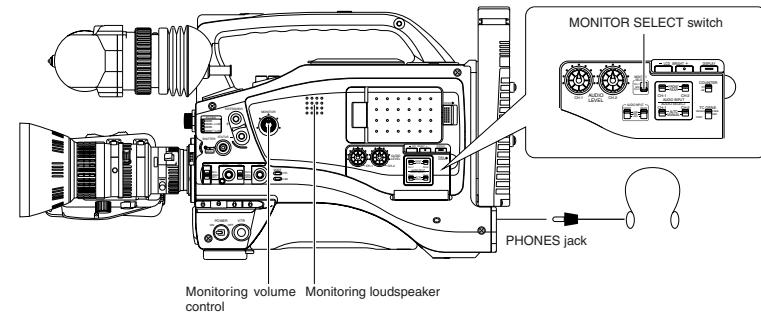

The audio input during recording, in record-pause or stop mode can be monitored through the monitoring loudspeaker or earphone.

- The monitoring audio is not output from the loudspeaker while the PHONES jack is in use.

- Select the audio channel to be monitored using the MONITOR SELECT switch.

CH-1 : The sound input to the CH-1 channel is output.

MIX : The sound input to the CH-1 and CH-2 channels is output mixed.

CH-2 : The sound input to the CH-2 channel is output.

- The Monitoring volume control adjusts the monitoring volume.

- The loudspeaker or earphone outputs an alarm tone in the case of an abnormal condition occurring in the unit.

An alarm tone is also output when the tape end is reached or when the battery is running down. The volume of the alarm tone is set with the ALARM VR LEVEL item on the OTHERS (2/2) menu screen. (OFF/LOW/MIDDLE/HIGH)

MEMO:

When connecting a stereotype earphone, make the following settings to output stereo sound.

- Set the MONITOR SELECT switch to MIX.
- Set the AUDIO MONITOR item on the AUDIO/VIDEO menu screen to STEREO.
- When AUDIO MONITOR in the AUDIO/VIDEO menu screen is set to "STEREO", only the audio of CH-1 is output from the monitoring loudspeaker.

- * Do not increase the audio monitoring volume excessively; otherwise howling with the camera microphone may occur.

7. SHOOTING OPERATION

7-1 Basic Recording Operation

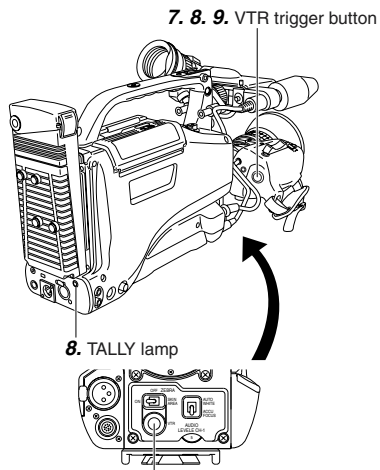
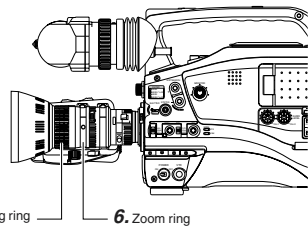
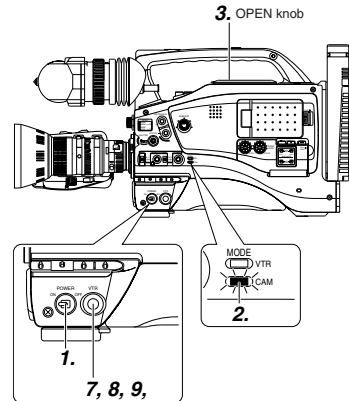

7. 8. 9. VTR trigger button

- Set the POWER switch to ON.
 - Power is supplied to the unit.
- The CAM indicator lights up. The GY-DV5000 is in the Camera mode when the CAM indicator is on.
- Slide the OPEN switch on the top section to open the cassette cover.
- Insert a videocassette into the cassette insertion slot.
 - Ensure that the erasure-prevention switch on the back of the cassette is set to REC and insert a videocassette properly. When the cassette is inserted, the tape is loaded and the unit enters the record-standby mode.
 - Slowly close the cassette cover.

MEMO:

- Use a standard DV videocassette or a MiniDV videocassette. (When a DVCAM cassette is used for recording, longer recording can be performed than the time indicated on the DVCAM cassette. For the recording time, regard the remaining tape indication displayed on the LCD or in the viewfinder as a guide.)
- Following loading of the cassette and when the POWER switch is turned ON/OFF, the built-in head cleaner will emit a sound while operating. This does not indicate a malfunction.
- After the cassette cover is closed, it takes about 10 seconds before the unit is ready for recording.

- Adjust the camera section settings and the white balance.
 - See "Camera Settings" on page 45.
 - See "White Balance Adjustment" on page 48.
- Point the camera at the subject and determine the angle of view and focus with the zoom lever and the focusing ring.

- Start recording. Press the VTR trigger button on the GY-DV5000 to start recording. Once recording has started, the BACK TALLY lamp on the rear section of the unit and the tally lamp on the viewfinder light red, and the REC indication in the viewfinder lights green.

MEMO:

The lightening conditions of the BACK TALLY lamp on the rear section of the unit and the tally lamp on the viewfinder can be changed by setting the BACK TALLY and FRONT TALLY items on the OTHERS (2/2) menu screen.

7. SHOOTING OPERATION

7-1 Basic Recording Operation (Cont'd)

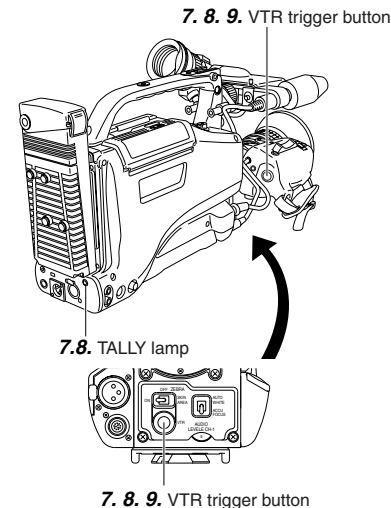
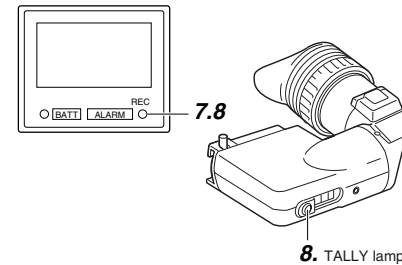

- To stop recording: Press the VTR trigger button on the unit or on the lens section again. The TALLY lamp and REC indicator lamp go out and the unit enters the record-standby mode. When the VTR trigger button is pressed, the unit enters the record-standby mode after rewinding the tape for about 2 seconds (back-spacing).

- To restart recording: Press the VTR trigger button on the GY-DV5000 or lens.

- Ending recording: Press the VTR trigger button to enter the record-standby mode and perform the following operations as required.

■ When it is required to unload the videocassette:

- Slide the OPEN knob to open the cassette cover.
- Press the EJECT button to take out the videocassette.

■ When the power should be turned off

Set the POWER switch to OFF. When the camera is not going to be used for a long period, detach the battery pack.

About the QUICK REC START Mode

If the VTR trigger button is pressed immediately after the videocassette is inserted, the mode becomes the QUICK REC START mode that enables quick start of recording. However, when shooting starts in the middle of the tape, a blank space appears as the new scene will not be linked smoothly with the previous image. Also, the time code does not continue. (Some overlap may also occur.) This function does not work during DV signal input.

CAUTION:

- The unit enters the record standby mode automatically at TAPE END. If this mode continues for 3 or 30 minutes, the mode switches to the tape protect mode.
 - See "LONG PAUSE TIME item on the OTHERS (1/2) menu screen" on page 77.
- If the VTR trigger button is pressed very quickly and repeatedly, or the POWER switch is moved immediately after the trigger button is pressed, the viewfinder REC indicator lamp may blink and the GY-DV5000 may not enter the record mode. To remedy this condition set the POWER switch to OFF and wait for 5 seconds or more before turning the power on again.
- A neat transition to the next recorded scene cannot be guaranteed if a recording is ended by turning the POWER switch or DC power supply OFF, or by removing the battery pack.
- Trial-shooting is always recommended before recording important events to confirm the recording is satisfactory.
- The microphone may pick up the sound of the lens' iris if the iris is changed abruptly or the iris is manually moved abruptly during recording. If the sound is found annoying, please purchase an optional microphone in order to move the microphone away from the lens or ensure that the iris is not changed abruptly during shooting.

7. SHOOTING OPERATION

7-2 Searching for Recorded Scenes (Edit Search)

In the record-standby mode, it is possible to search for a scene when you want to check the recorded scene or continue recording from the scene.

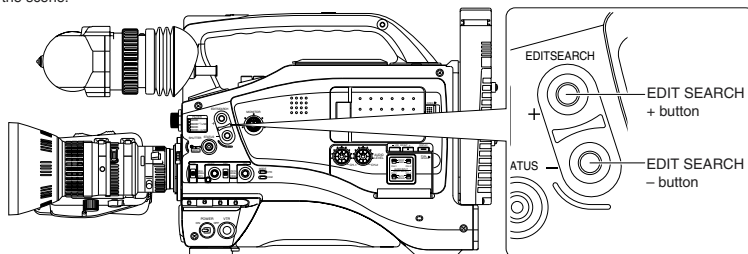

Screen indications during Edit Search

During Edit Search, the VTR mode is indicated as ED.FWD or ED.REV on the LCD monitor or in the viewfinder. (When Status 1 screen is displayed.)

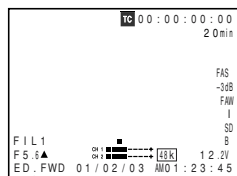

ED.FWD: Forward search
ED.REV: Reverse search

Engage the record-standby mode.

■ Searching the tape in forward direction

1. Press the EDIT SEARCH + button. While the + button is pressed, playback takes place at the normal speed.

2. When the EDIT SEARCH + button is released, the standby mode is reengaged.

■ Searching the tape in reverse direction

1. Press the EDIT SEARCH - button. While the - button is pressed, reverse playback takes place at -1 times the normal speed.

2. When the EDIT SEARCH - button is released, the standby mode is reengaged.

MEMO:

- Block noise may appear and the image may freeze during search.

7. SHOOTING OPERATION

7-3 If the Record-Standby Mode Continues

Setting the time before the tape protection mode is engaged

The time before the tape protection mode is engaged from the record-standby mode can be set to 30 minutes or 3 minutes with the LONG PAUSE TIME item on the OTHERS (1/2) screen menu.

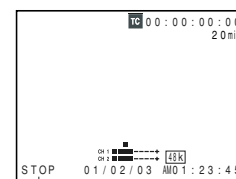

VTR mode indication

When the record-standby mode has continued for about 30 minutes, the GY-DV5000 automatically stops drum rotation in order to protect the tape. (Tape protect mode)

- In the tape protect mode, STOP is shown as the VTR mode indication on the LCD monitor and in the viewfinder screen. (Status 1 screen)

■ To start recording from the tape protect mode, press the VTR trigger button.

- The drum starts rotating, and recording starts after about 3 seconds.

■ To return to the record-standby mode from the tape protect mode, press the RET button.

7-4 Checking Recorded Contents in Record-Standby Mode (Recording Check Function)

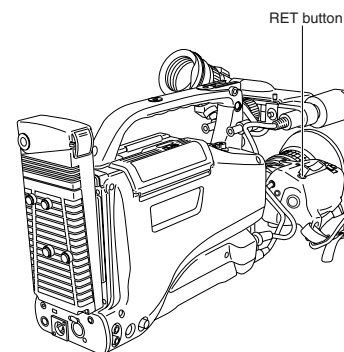

This function is available only when the GY-DV5000 is in the standby mode.

In the record-standby mode, approximately 2 seconds of the last recorded portion can be played back.

- The recorded contents can be checked on the LCD monitor or in the viewfinder or on a monitor connected to the MONITOR OUT or Y/C OUT connectors.
- The video image from the VTR section is shown on the LCD monitor or in the viewfinder or on the monitor connected to the MONITOR OUT or Y/C OUT connectors.

1. In the record-standby mode, press the RET button on the camera lens section.

- The tape is slightly rewound and played back for approximately 2 seconds.

After playback is finished, the tape returns to the position at which the RET button is pressed and the record-standby mode resumes.

■ When the RET button is kept pressed, the tape is rewound and played back for approximately 15 seconds at maximum.

- Pressing the VTR trigger button during playback will put the unit in REC standby mode. The camera will automatically return to recording mode after playback.

* This function does not work when the GY-DV5000 is in the stop mode.

* During recording check, the following indication will appear if the error rate increases due to head clogging, etc.

- "HEAD CLEANING REQUIRED!" is shown on the LCD monitor or in the viewfinder. (When the Status 0, 1, 3 screen is displayed.)

7. SHOOTING OPERATION

7-5 Recording the Color Bars

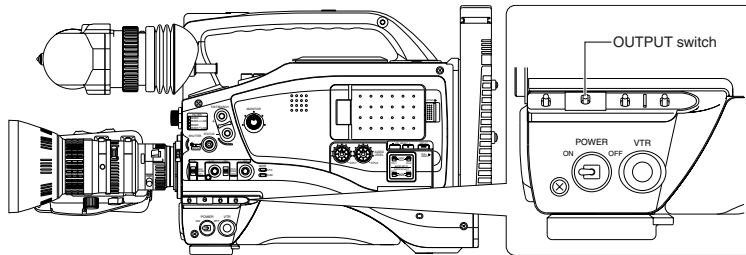

Color bar signal of the built-in signal generator

An SMPTE standard color bar is output.

White	Yellow	Cyan	Green	Magenta	Red	Blue
Blue	Black	Magenta	Black	Cyan	Black	White
Black	White	Black				

Whether the camera image should be output or whether the color bar of the built-in signal generator should be output can be selected during record-standby and recording.

■ To output the color bar, set the OUTPUT switch to the BARS side.

■ To output the camera image, set the OUTPUT switch to the CAM AUTO KNEE ON/OFF side.

MEMO:

Whether or not the audio reference signal should be output while the color bar is output can be selected with the TEST TONE item on the AUDIO/VIDEO menu screen.

8. PLAYBACK MODE

8-1 Playback Procedure

Recorded pictures can be viewed in the viewfinder, or on the LCD monitor, or on the monitor connected to the video output connector.

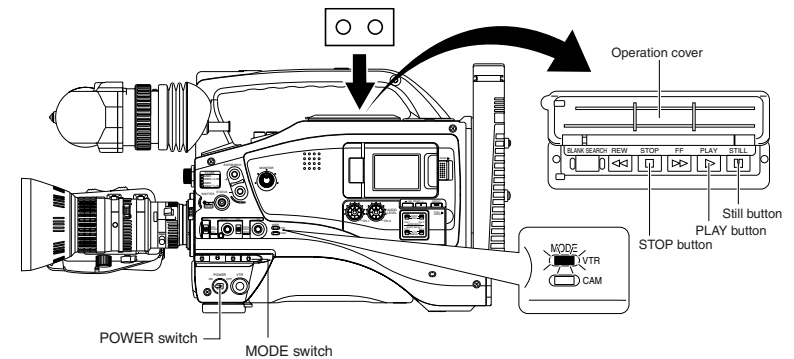

MEMO:

- The GY-DV5000 can play back the following three types of videocassettes:
 - DV videocassette
 - MiniDV videocassette
 - DVCAM videocassette
- Tapes recorded in the LP mode cannot be played back.

1. Set the POWER switch to ON.
2. Set the unit to the VTR mode.
 - Press the MODE switch upward to turn on the VTR indicator.
 - Playback is also possible in the Camera mode.
 - Playback operation becomes possible when the STOP button is pressed to set the VTR operation mode indicator to indicate STOP.
3. Load the recorded videocassette correctly.
 - Slide the OPEN knob on the top section of the unit to open the cassette cover. Then insert the videocassette and close the cover.
 - When the videocassette is loaded, the unit enters the Stop mode.
4. Open the operation cover on the upper section of the unit.
 - Slide the operation cover to the side to open.
5. Press the PLAY button.
 - Playback starts.
6. Press the STILL button to stop playback temporarily.
 - The unit enters the still mode.
7. To re-start playback, press the PLAY button.
8. To stop playback or the still mode, press the STOP button.

MEMO:

- In the VTR mode, the camera image is not output on the LCD monitor, in the viewfinder or through the video output connector.
- The VTR mode is indicated on the LCD monitor and in the viewfinder. (Status screen)

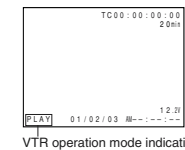

VTR operation mode indication

- When the still picture mode or stop mode has continued for a while, the unit automatically switches to the tape protect mode.
 - Tape protect mode: Drum rotation is stopped in order to protect the tape.
- Noise may appear in the picture in the still mode.
- When the automatic tracking function is activated at the start of the playback mode, digital noise may appear in the playback image.
- This unit does not allow manual tracking adjustment.
- When playing back a tape that was recorded on another unit, digital noise may appear during playback.
- Following loading of the tape, the built-in head cleaner will emit a sound while operating. This does not indicate a malfunction.
- The data recorded for the date and time or time code on the tape can be shown on the screen. To enable or disable the display is selected on the menu screen:
 - Display of date and time: TIME/DATE menu screen
 - Display of time code: LCD/VF (2/2) menu screen

8. PLAYBACK MODE

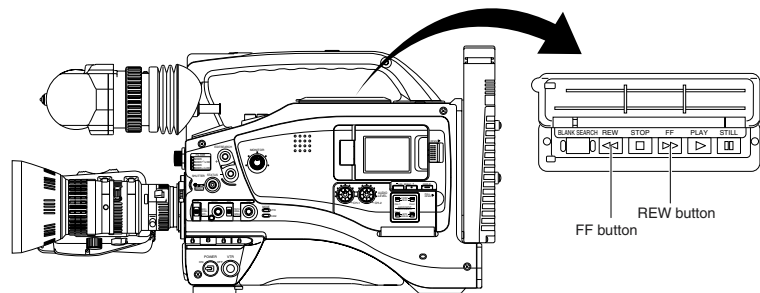

8-2 Fast-Forward, Rewind

- Press the FF button in the stop mode to fast forward the tape. Press the REW button in the stop mode to rewind the tape.
- Press the STOP button to stop fast forwarding or rewinding.

MEMO:

- When the tape approaches the end during fast forwarding or rewinding, the tape speed decelerates to protect the tape.
- The time required for fast forwarding and rewinding may become longer when used in a cold environment. This is not a malfunction.

8-3 Search

- Press the FF button in the play mode or still mode to search the tape in the forward direction. Playback takes place while fast forwarding.

Pressing the REW button executes search of the tape in the reverse direction. Playback takes place while rewinding. (Each press on the button switches the speed to X5, X9, and X20.)

- Press the PLAY button to resume normal playback.
- Press the STOP button to stop.

MEMO:

- To output sound during the search, set the A.OUT AT SEARCH item on the AUDIO menu screen to ON.
- Block noise may appear in the picture or the image may freeze during the search.

8-4 Blank Search

BLANK SEARCH button

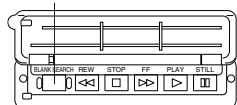

Status screen

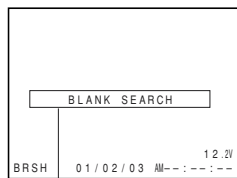

Blank search operation indicator

This function can be used to locate blank portions (unrecorded portions) on the tape, such as the end of a recording.

- Engage the stop or still mode.
- Press the BLANK SEARCH button.
 - Blank search starts. When a blank part (unrecorded part) on the tape is detected, the unit enters the STILL status in the VTR mode and the Standby status in the CAM mode.
- To stop blank search, press the STOP button.

MEMO:

"BLANK SEARCH" is indicated on the LCD monitor and in the viewfinder during blank search. (When the Status screen is shown.)

8. PLAYBACK MODE

8-5 Outputting CH-3, CH-4 Channel Audio

The DV format is capable of recording up to 4 channels when the 12-bit, 32 kHz sampling frequency is employed. The GY-DV5000 records audio on the two channels CH-1 and CH-2. (4-channel recording is possible in the case of DV input.) When the GY-DV5000 is used for playback of a tape that was recorded on another unit with audio recorded on the CH-3 and CH-4 channels, the AUDIO SELECT item on the AUDIO/VIDEO menu screen must be set.

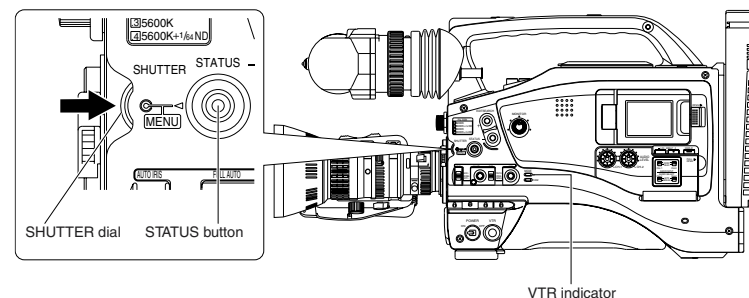

TOP MENU screen

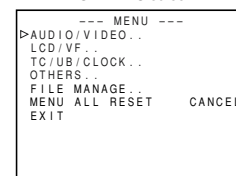

AUDIO/VIDEO menu screen

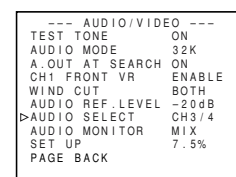

Setting

- Confirm that the GY-DV5000 is in the VTR mode. (VTR indicator: On)

- Press the STATUS button for 1 second or longer to display the TOP MENU screen.
- Rotate the SHUTTER to align the cursor (▶) with the AUDIO/VIDEO menu, and then press the SHUTTER dial.
 - The AUDIO/VIDEO menu screen appears.
- Rotate the SHUTTER to align the cursor (▶) with the AUDIO SELECT item, and then press the SHUTTER dial.
 - The setting area of the selected item starts blinking.
- Rotate the SHUTTER dial to change the setting.
 - CH1/2** : To reproduce the sound (CH-1, CH-2) recorded during shooting.
 - MIX** : To reproduce the sound recorded during shooting (CH-1, CH-2) and the after-recorded sound (on CH-3 and CH-4) simultaneously.
 - CH3/4** : To reproduce the sound after-recorded on CH-3 and CH-4.

- When the SHUTTER dial is pressed, the set value is confirmed.

- To return to the normal screen, use either of the following methods.
 - Press the STATUS button or
 - Return to the TOP MENU screen and then select the EXIT item before pressing the SHUTTER dial.

MEMO:

After-recording on the CH-3 and CH-4 channels is not possible.

9. USING EXTERNAL COMPONENTS

9-1 Connecting a Video Component with DV Connector

Connecting the GY-DV5000 to another video component equipped with DV I/O connector (IEEE1394 standard) using a DV cable (optional) enables dubbing of digital signals with high picture quality and high-quality sound.

Rear section of GY-DV5000

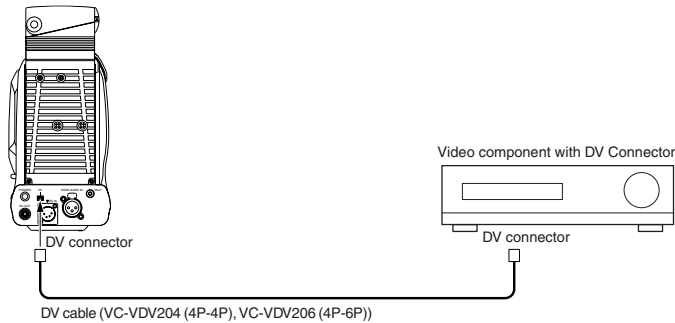

When Using the GY-DV5000 as Playback Unit (Dubbing to Another Video)

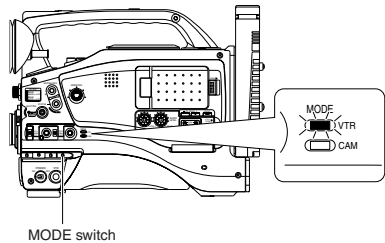

- Dubbing still images makes the images coarser. In addition, noise may appear in the sound.

1. Connect the units with the DV cable.
2. Turn ON both units.
3. Place the GY-DV5000 in the VTR MODE. Press the MODE switch upward to turn on the VTR indicator.
4. Insert the videocassettes.
GY-DV5000: Insert the recorded videocassette.
Recording unit: Insert the videocassette to be dubbed to.
5. Press the PLAY button on the GY-DV5000 to start playback.
6. Start recording on the recording unit.
For details, see the instructions to the unit used for recording.
7. When dubbing is completed.
Stop recording on the recording unit, and then press the STOP button on the GY-DV5000 to stop playback.

MEMO:

- The operation methods differ with the characteristics and specifications of the connected equipment. Even if connection is possible, operation or data communication may sometimes be impossible to perform.
- If block noise appears or the sound falls out, try to disconnect and then connect the DV cable again, or turn the power to the GY-DV5000 off and then on again.
- When connecting to a D-9 (digital-S) component with an IEEE1394 connection, the date and time data are not output from the D-9 component. Also, the date and time data cannot be recorded on the D-9 component. When making an IEEE1394 connection with a D-9 component, install SA-DV60 on the device.
- If the power to the component connected to the DV connector is turned on, or the video input is changed, noise may appear in the audio. When these operations have to be performed, reduce the sound volume of the audio component, speaker, etc., connected to the GY-DV5000 to a minimum.
- When using the TC DUPLICATE mode of BR-DV600A, set Menu No. 416 [NON DROP/DROP] of BR-DV600A according to the framing mode (Drop/Non-drop) of the tape to be played back on this unit.

9. USING EXTERNAL COMPONENTS

When Using the GY-DV5000 as RECORDING Unit (Dubbing From Another Videocassette)

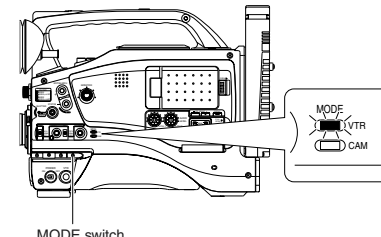

MODE switch

Date and time data:

Data transmitted from the playback unit is recorded.

Time code:

The data generated by the GY-DV5000's time code generator is recorded.

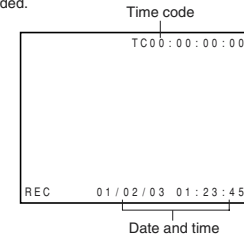

1. Turn ON both units.
2. Place the GY-DV5000 in the VTR MODE. Press the MODE switch upward to turn on the VTR indicator.
3. Insert the videocassettes.
GY-DV5000: Insert the videocassette to be dubbed to.
Playback unit: Insert the recorded videocassette.
4. Connect the units with the DV cable.
5. Start playback on the playback unit.
For details, see the instructions to the unit used for playback.
 - The playback picture from the playback unit appears on the GY-DV5000's LCD monitor and viewfinder screen.
6. Press the VTR trigger on the GY-DV5000 to start recording.
 - To temporarily pause the recording, press the VTR trigger.
 - To restart the recording, press the VTR trigger again.
7. When dubbing is completed.
Press the VTR trigger or the STOP button on the GY-DV5000 to stop recording, and then stop playback on the playback unit.

MEMO:

Depending on the player, sound may not be heard momentarily from this unit when switching modes from STILL to PLAY.

Backup Recording of the GY-DV5000's Camera Image and Sound Through the DV Connector

The GY-DV5000's camera image and sound can be recorded for backup on another component that is equipped with DV connector. Recording operation is performed on the backup equipment simultaneously with performance of the recording operations on the GY-DV5000.

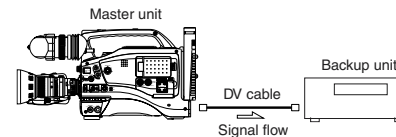

Connections

Use the GY-DV5000 as the master unit. Connect the master unit and the backup unit with a DV cable

Settings

- Master unit (GY-DV5000)
 - Place in CAMERA mode.
 - Set the DV REC TRIGGER item on the OTHERS (1/2) Menu Screen to ON.
- Backup unit
 - Place in DV signal input mode.
 - * Depending on the used component, it may be necessary to set "REMOTE SELECT".
 - When BR-DV600A or BR-DV3000 is used, set the Backup Recording function to OFF.
 - Insert the tape and set to STOP or REC PAUSE status.

Operation

Start and stop of recording on the backup unit takes place in accordance with the operation of the VTR trigger button on the master unit.

Start and stop of recording on the backup unit takes place in accordance with start and stop of recording on the master unit.

MEMO:

- When the backup recording is started, the "TRIGGER TO DV" indication is shown on the LCD or in the viewfinder for 3 seconds.
- When the Backup Recording function of BR-DV600A or BR-DV3000 is used, the DV REC TRIGGER item on the GY-DV5000's OTHERS (1/2) Menu Screen should be set to OFF.
- If the backup device is equipped with a feature to record time codes input from the DV IN/OUT terminal (TC DUPLICATE feature), time code data the same as on the master side can be recorded.
- When using BR-DV600A as a backup device and switching GY-DV5000 from the EDIT SEARCH or PLAYBACK mode to the RECORD mode, noise will be noticed on the monitor output screen of BR-DV600A (backup will be correctly recorded).

10. TIME CODE OPERATION

The GY-DV5000 records SMPTE-standard time codes and user's bits. In the play mode or the record mode, the reproduced time codes or user's bits are shown on the LCD monitor or in the viewfinder.

- Time code data cannot be output through the unit's connectors.

10-1 Displaying Time Code

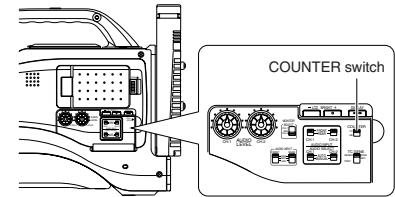

The time codes or user's bits can be shown on the LCD monitor or in the viewfinder during playback and recording as follows. (Status screen)

Setting

- Set the TC/UB item on the LCD/VF (2/2) menu screen to ON.
 - Time codes or user's bit data are displayed on the Status screen.
- Whether time codes or user's bit data should be displayed is selected with the COUNTER switch inside the cover on the side.
 - TC : Time codes are displayed. The symbol between the seconds and the frame differs with the framing mode. (Colon or dot)
 - UB : User's bit data is displayed.

The time codes or user's bits can be shown on the LCD monitor or in the viewfinder during playback and recording as follows. (Status screen)

Time code indication

Example
Time code indication
00:00:00:00
Non-drop frame (:)
Drop frame (.)
User's bits indication
FF EE DD 20

Status 1 screen

```

STBY 01/02/03 01:23:45
    
```

10-2 Presetting and Recording of Time Code

The time codes or user's bit data from the internal time code generator can be recorded at the time of recording scenes.

To preset the Time Code, make the following settings.

TC GENE. switch

Set to PRESET REC or PRESET FREE.

PRST REC : The data preset in the time code generator runs only during recording. Use this setting if it is necessary to record continual time codes across different scenes. * However, approximately ±1-frame variations may occur in scene accuracy.

PRST FREE : The time code starts to run from the time it is preset in the time code generator.

TC/UB/CLOCK menu screen

Use the DROP/NON DROP item to select the framing mode for the time code generator.

DROP : The time code generator's running method is set to the drop frame mode. Use this setting when placing emphasis on the recording time.

NON DROP : The time code generator's running method is set to the non drop frame mode. Use this setting when placing emphasis on the number of frames.

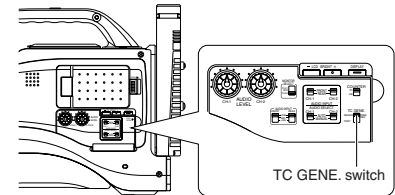

TC/UB/CLOCK menu screen

```

--- TC/UB/CLOCK ---
TC PRESET 00:00:00:00
EXECUTE
TC CLEAR CANCEL
UB PRESET 00 00 00 00
EXECUTE
UB CLEAR CANCEL
DROPNON DROP DROP
TIME/DATE..
PAGE BACK
    
```

Framing mode:
Non-drop/Drop setting

Drop frame/Non-drop frame mode

In the NTSC system, the actual number of frames per 1 second is approximately 29.97 frames, but per time code 30 frames are processed. To compensate for this difference, the mode called "drop mode" drops frame 00 and 01 for every minute not divisible by 10.

The "non-drop frame mode" is when no frames are dropped and the actual time shift is neglected.

10. TIME CODE OPERATION

TIME CODE PRESETTING PROCEDURE

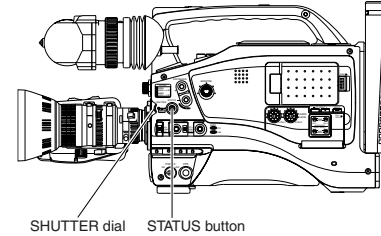

TOP MENU screen

```

--- MENU ---
CAMERA OPERATION..
CAMERA PROCESS..
AUDIO/VIDEO..
LCD/VF..
DTC/UB/CLOCK..
OTHERS..
FILE MANAGE..
MENU ALL RESET CANCEL
EXIT
    
```

TC/UB/CLOCK menu screen

```

--- TC/UB/CLOCK ---
DTC PRESET 00:00:00:00
EXECUTE
TC CLEAR CANCEL
UB PRESET 00 00 00 00
EXECUTE
UB CLEAR CANCEL
DROPNON DROP DROP
TIME/DATE..
PAGE BACK
    
```

Time code (hour, min, sec, frame)

PRESETTING USER'S BIT DATA

```

--- TC/UB/CLOCK ---
TC PRESET 00:00:00:00
EXECUTE
TC CLEAR CANCEL
UB PRESET 00 00 00 00
EXECUTE
UB CLEAR CANCEL
DROPNON DROP DROP
TIME/DATE..
PAGE BACK
    
```

Align the cursor with UB

The time code and user's bit data are preset on the TC/UB/CLOCK menu screen.

- Display the TC/UB/CLOCK menu screen.
 - Press the Status button for 1 second or more to display the TOP MENU screen.
 - Rotate the SHUTTER dial to align the cursor (▶) with the TC/UB/CLOCK item, and then press the SHUTTER dial.
 - The TC/UB/CLOCK menu screen appears.
- Set the time code (hours, minutes, seconds, frames).
 - Rotate the SHUTTER dial to align the cursor (▶) with TC PRESET, and then press the SHUTTER dial.
 - The first digit of the time code blinks. The blinking digit is the one to be set.
 - When the SHUTTER dial is pressed, the blinking digit changes.
 - When the SHUTTER dial is rotated, the value of the blinking digit changes. When the SHUTTER dial is rotated upward, the value becomes higher. When rotated downward, the value becomes smaller.
 - Repeat the procedure described in ② and ③ above to set the desired value for all digits.
 - After setting the frame digit, press the SHUTTER dial to make EXECUTE blink. The setting values are confirmed when the SHUTTER dial is pressed again. To cancel the setting, select CANCEL and press the SHUTTER dial.
- When all the digits are set.
 - Press the STATUS button to return to the normal screen or
 - Rotate the SHUTTER dial to align the cursor (▶) with the PAGE BACK item, and then press the SHUTTER dial to return to the TOP MENU screen.

The user's bit data are preset with the UB PRESET item on the TC/UB/CLOCK menu screen. The method for setting is the same as the method for setting the time code described above.

- The user's bit can be specified using numerals or alphabetic letters from 0 to F for each digit.

CAUTION:

Do not set all the digits of the user's bit data to "F". Reading of the data during playback will not be possible for an all-F setting.

Zero-resetting the Time Code or User's Bit Data

This is performed with the CLEAR item on the TC/UB/CLOCK menu screen. (Performed separately for the time code and the user's bit data.)

- Rotate the SHUTTER dial to align the cursor (▶) with the CLEAR item, and then press the SHUTTER dial.
- Rotate the SHUTTER dial to select EXECUTE as the setting value, and then press the SHUTTER dial.

10. TIME CODE OPERATION

10-3 Recording Time Codes in Continuation of Time Codes Recorded on Tape

The GY-DV5000 also incorporates a time code reader. Therefore, when the unit enters record mode from record-standby mode, it can read the time code data recorded on the tape and record time codes in continuation of the existing data. The recorded user's bit data are identical to the user's bit data recorded on tape.

- However, approximately ± 1 -frame variations may occur in scene accuracy.
To enable this function, set the time code related switches as follows before starting recording.

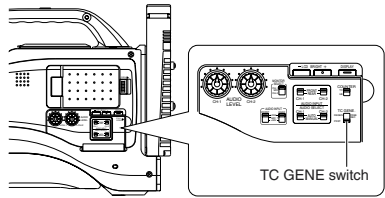

Setting

- Set the TC GENE switch inside the cover on the side to REGEN.
- The time code framing mode automatically becomes the mode (drop frame or non drop frame) already recorded on the tape.

10-4 Reproducing Time Codes

The GY-DV5000 incorporates a time code reader. During playback, the time code or user's bit data recorded on the tape is displayed on the LCD monitor or in the viewfinder. (Status screen)

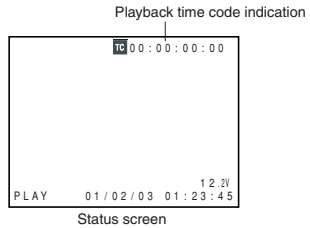

Setting

- ☞ See "Displaying Time Code" on page 62.

CAUTION:

A time code with a duration of more than 2 hours may not be displayed correctly by DV components for general consumer use, as some of these lack the capability to display longer time codes.

11. MENU SCREENS

11-1 Menu Screen Configuration

The Menu Screen consists of multiple layers of menu screens as shown below. The menu screen to be set is selected from the TOP MENU screen in accordance with the function or purpose.

The items on the menu screens differ with the Camera mode and the VTR mode. The contents of set items are stored in the GY-DV5000's memory and are retained even when the power is turned off.

The FILE MANAGE menu screen can be used to store the menu setting contents in two types of files (FILE CAM1, FILE CAM2) on the GY-DV5000. When saving menu setting contents that remain more or less fixed, these are stored in FILE CAM1 or FILE CAM2. A saved file (FILE CAM1 or CAM2) can be read out on the FILE MANAGE menu screen.

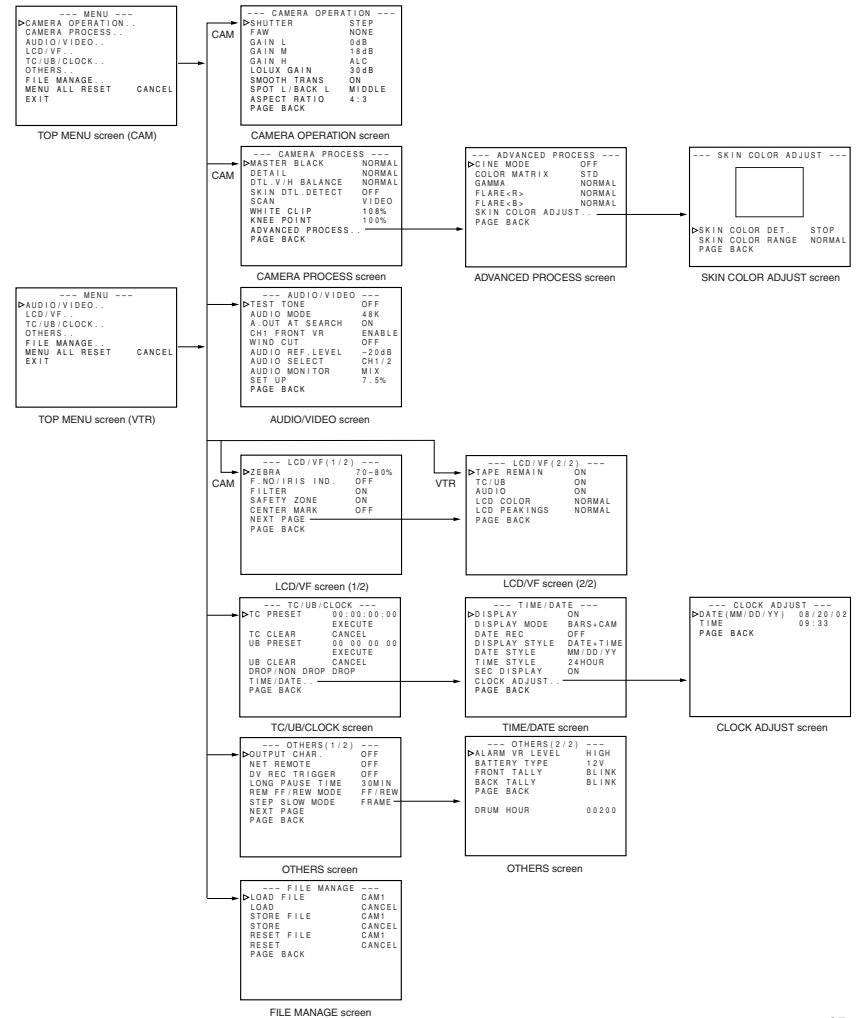

11. MENU SCREENS

11-2 Setting Menu Screens

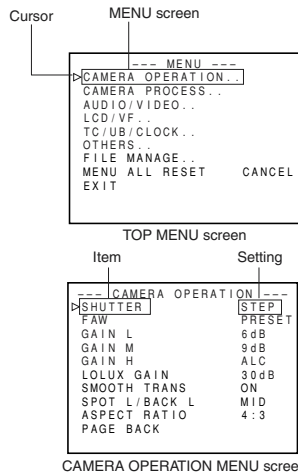
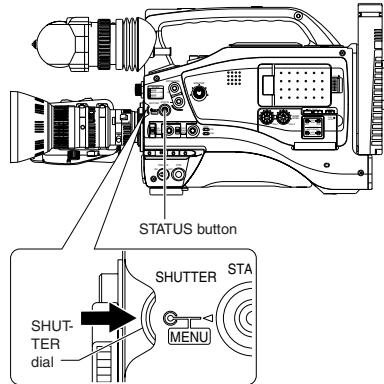

Make the settings while observing the LCD monitor or the viewfinder screen. If the OUTPUT CHAR. item on the OTHERS (1/2) screen is set to ON, the menu screen can also be viewed on a monitor connected to the MONITOR OUT or Y/C OUT connector.

- Set the POWER switch to ON.
- Set the mode of the GY-DV5000 with the MODE switch. (Camera mode or VTR mode)
- Press the STATUS button for 1 second or longer.
 - The TOP MENU screen appears.
- Select the menu screen to be set. Rotate the SHUTTER dial to align the cursor (▶) with the menu screen to be set, and then press the SHUTTER dial.
 - The selected menu screen appears.
- Select the menu item on the menu screen. Rotate the SHUTTER dial to align the cursor (▶) with the item to be set, and then press the SHUTTER dial.
 - The setting area of the selected item starts blinking, and the setting can now be made.
- Change the setting. Rotate the SHUTTER dial to change the setting, and then press the SHUTTER dial.
 - To change multiple items, repeat the procedures in steps 5. and 6. above.
- Return to the TOP MENU. Rotate the SHUTTER dial to align the cursor (▶) with the PAGE BACK item, and then press the SHUTTER dial.
 - To change settings on other menu screens, repeat the procedures in steps 4. to 7. above.
 - To save the set contents in FILE CAM1 or CAM2, select the FILE MANAGE menu screen and perform the operations for saving to file. See "FILE MANAGE Menu Screen" on page 67.
- To return to the normal screen after completing the settings, use either of the following methods.
 - Press the STATUS button
 - or
 - Return to the TOP MENU screen and align the cursor (▶) with the EXIT item, and then press the SHUTTER dial.

11-3 FILE MANAGE Menu Screen

The FILE MANAGE menu screen is used to perform the following tasks.

- Storing menu setting contents in two types of files (CAM1, CAM2). When saving menu setting contents that remain more or less fixed, these are stored in CAM1 or CAM2.
- Reading out a stored file (CAM1, CAM2, or current settings).
- Resetting menu setting contents to the factory settings.

■ Display the FILE MANAGE menu screen.

- Select the FILE MANAGE item on the TOP MENU screen, and then press the SHUTTER dial.
- The FILE MANAGE menu screen appears.

Storing Setting Values

- Rotate the SHUTTER dial to align the cursor (▶) with the STORE FILE, and then press the SHUTTER dial.
 - The area for setting the file name starts blinking.
- Rotate the SHUTTER dial to select the storage destination file (CAM1 or CAM2), and then press the SHUTTER dial.
- Rotate the SHUTTER dial to align the cursor (▶) with the STORE item, and then press the SHUTTER dial.
 - The CANCEL indicator in the setting value area blinks.
- When you rotate the SHUTTER dial to make EXECUTE in the setting value area blink and then press the SHUTTER dial, the menu settings are stored in the specified file.

Reading Out a Menu Settings File

- Rotate the SHUTTER dial to align the cursor (▶) with the LOAD FILE, and then press the SHUTTER dial.
 - The area for setting the file name starts blinking.
- Rotate the SHUTTER dial to select the file where the setting values are stored (CAM1 or CAM2), and then press the SHUTTER dial.
- Rotate the SHUTTER dial to align the cursor (▶) with the LOAD item, and then press the SHUTTER dial.
 - The CANCEL indicator in the setting value area blinks.
- When you rotate the SHUTTER dial to make EXECUTE in the setting value area blink and then press the SHUTTER dial, the menu settings stored in the specified storage location are read out. The power is automatically turned OFF and ON again.

Resetting the Menu Settings to the Factory Settings.

- Rotate the SHUTTER dial to align the cursor (▶) with the RESET FILE, and then press the SHUTTER dial.
 - The area for setting the file name starts blinking.
- Rotate the SHUTTER dial to select the name of the file to be reset, and then press the SHUTTER dial. CAM1, CAM2 CURRENT: Currently set values
- Rotate the SHUTTER dial to align the cursor (▶) with the RESET item, and then press the SHUTTER dial.
 - The CANCEL indicator in the setting value area blinks.
- When you rotate the SHUTTER dial to make EXECUTE in the setting value area blink and then press the SHUTTER dial, the set values are reset. The power is automatically turned OFF and ON again.

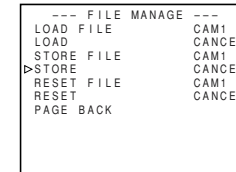
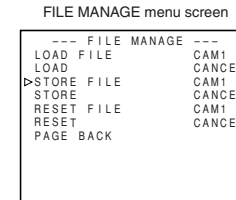
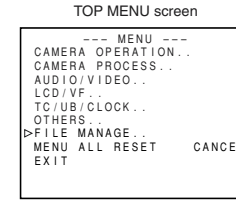

- When the LOAD, STORE, RESET items are set to CANCEL, none of the operations are executed.
- To close the FILE MANAGE menu screen: Align the cursor (▶) with the PAGE BACK item, and then press the SHUTTER dial. Or, press the STATUS button.

MEMO:

The currently set value is not reset even when CAM1 or CAM2 is reset. To reset also the currently set value, select "CURRENT".

11. MENU SCREENS

11-4 TOP MENU Screen

Different menu screens are displayed depending on whether the GY-DV5000 is in the Camera mode or in the VTR mode. In the VTR mode, the CAMERA OPERATION and CAMERA PROCESS menu screens are not displayed.

Item	Function	Variation Range	Initial Setting
CAMERA OPERATION	Displays a menu screen for setting the operation mode for camera shooting. ● This item is only displayed in the Camera mode.	—	—
CAMERA PROCESS	Displays a menu screen for adjustments of the picture quality of the camera image. The ADVANCED PROCESS menu screen and SKIN COLOR ADJUST screen can be displayed through the CAMERA PROCESS menu screen. ● This item is only displayed in the Camera mode.	—	—
AUDIO/VIDEO	Displays a menu screen related to audio and video.	—	—
LCD/VF	Displays a menu screen for selecting whether to display characters on the LCD monitor or in the viewfinder, and for adjustments of the picture quality of LCD monitor. It consists of two screens.	—	—
TC/UB/CLOCK	Displays a menu screen for setting the time code, user's bit data, date and time. The ways that the date and time are recorded together with the display style are set here. The TIME/DATE menu screen and CLOCK ADJUST screen can be displayed through the TC/UB/CLOCK menu screen.	—	—
OTHERS	Displays a menu screen for setting other functions and to display the hour meter. It consists of two screens.	—	—
FILE MANAGE	Displays the FILE MANAGE menu screen. The menu screen setting contents can be stored in the GY-DV5000 in files (FILE CAM1 or CAM2), and the menu screen settings stored in files can be read out. The menu screen setting contents can also be reset to the initial setting values. (Individual files.) ☞ See "FILE MANAGE Menu Screen" on page 67.	—	—
MENU ALL RESET	Selects whether the menu screen settings should be reset to the initial setting values. If reset operation is performed, the power is automatically turned off and then on again. The Camera mode and VTR mode menu settings are reset. CANCEL: Reset not performed EXECUTE: Reset	CANCEL EXECUTE	CANCEL
EXIT	The normal screen returns when the SHUTTER dial is pressed while the cursor is aligned with this item.	—	—

11. MENU SCREENS

11-5 CAMERA OPERATION Menu Screen

The CAMERA OPERATION menu screen is only displayed in the Camera mode.

Item	Function	Variation Range	Initial Setting
SHUTTER	The SHUTTER button on the right side section is used to select STEP for fixed shutter speed or V.SCAN variable scanning rate for shooting computer monitor screens. STEP :Enables setting of different fixed shutter speeds. [1/7.5, 1/15, 1/30, 1/60, 1/100, 1/250, 1/500, 1/1000, 1/2000, 1/4000, 1/10000] VARIABLE :Selected when shooting computer monitor screens, etc. [Variable range: 60.1 to 2084.6 Hz]	STEP VARIABLE	STEP
FAW	Selects the W.BAL switch (Ⓢ on page 13) position to which the FAW (Full-Time Auto White Balance Adjustment) function is to be assigned. NONE :FAW function is not used. A :FAW is assigned to the A position. B :FAW is assigned to the B position. PRESET :FAW is assigned to the PRESET position.	NONE A B PRESET	NONE
GAIN L GAIN M GAIN H	Selects the gain value in each position of the GAIN switch (Ⓢ on page 13).	-3dB 0dB 3dB 6dB 9dB 12dB 15dB 18dB ALC	L: 0dB M: 9dB H: 18dB
LOLUX GAIN	Sets the gain up value when in the LOLUX mode. (SS: Shutter speed 1/30)	24dB 24dB+SS 30dB 30dB+SS 36dB 36dB+SS	30dB
SMOOTH TRANS	Smoothens the transition when the GAIN switch (Ⓢ on page 13), or WHT.BAL switch (Ⓢ on page 13) is switched over and achieves gradual change in place of sudden change. However, the smooth transition function does not function when switching the GAIN switch set in ALC, FAS button and the LOLUX button. ON :Activates the smooth transition function. OFF :Deactivates the smooth transition function.	ON OFF	OFF
SPOT L/ BACK L	Sets the level of auto iris when setting the AUTO IRIS switch to BACK L or SPOT L. LOW : Lowers the iris level. MIDDLE : Opens/Closes the iris by 1 step from the standard state. HIGH : Raises the iris level.	LOW MIDDLE HIGH	MIDDLE
ASPECT RATIO	Sets the image size of the video signal. 4:3 :4:3 aspect ratio image output. LETTER :LETTER BOX (16:9 aspect ratio) image output. ● When setting DATE REC in the TIME/DATE menu screen to BARS or BARS+CAM, the screen size will be fixed at an aspect ratio of 4:3. ● When ASPECT RATIO is set to LETTER, 16:9 aspect ratio distinction ID signal is outputted from the Y/C OUT terminal.	4:3 LETTER	4:3
PAGE BACK	The TOP MENU returns when the SHUTTER dial is pressed with the cursor at this position.	—	—

11. MENU SCREENS

11-6 CAMERA PROCESS MENU Screen

The CAMERA PROCESS menu screen is only displayed in the Camera mode.

Item	Function	Variation Range	Initial Setting
MASTER BLACK	Adjusts the pedestal level (master black), which is the reference of black. ● To increase the pedestal level Increase the number. (UP) ● To decrease the pedestal level Decrease the number. (DOWN)	MAX (10) 9 to NORMAL (0) to -9 MIN (-10)	NORMAL
DETAIL	Adjusts the detail enhancement level. ● To sharpen details Increase the number. (UP) ● To soften details Decrease the number. (DOWN) Note: When LOLUX is ON, "FIX" is displayed and setting is not possible.	MAX (10) 9 to NORMAL (0) to -9 MIN (-10)	NORMAL
DTL. V/H BALANCE	Sets the direction, horizontal (H) or vertical (V), in which stronger detail enhancement is applied. To strengthen the H enhancement Increase the number (UP). To strengthen the V enhancement Decrease the number (DOWN). Note: When LOLUX is ON, "FIX" is displayed and setting is not possible.	H-MAX (5) 4 to NORMAL (0) to -4 H-MIN (-5)	NORMAL
SKIN DTL DETECT	Sets the Skin Detail function to ON or OFF. ON :Skin Detail function activated. OFF :Skin Detail function not activated. ☞ See "Using the Skin Detail Function" on page 86.	ON OFF	OFF
SCAN	Increases the vertical resolution. ● VIDEO :Vertical resolution 380 lines. ● FRAME MODE :Vertical resolution 450 lines Note: In the FRAME MODE the bright sections may be coloured depending on the colour temperature of the subject.	VIDEO FRAME MODE	VIDEO
WHITE CLIP	Sets the point where white clipping is to take place for an input video signal with a high luminance level. 108% :The luminance level is white-clipped at the point of 108%. 100% :The luminance level is white-clipped at the point of 100%. If the screen appears too white even with the point set at 108%, set the point at 100%.	108% 100%	108%
KNEE POINT	Sets the knee point (brightness level) when the AUTO KNEE function is set to OFF.	100% 96% 92% 88% 84% 80%	100%
ADVANCED PROCESS	Displays the ADVANCED PROCESS Screen. ☞ See "ADVANCED PROCESS Screen" on page 71.		
PAGE BACK	The TOP MENU returns when the SHUTTER dial is pressed with the cursor at this position.	—	—

11. MENU SCREENS

11-7 ADVANCED PROCESS Screen

Item	Function	Variation Range	Initial Setting
CINE MODE	When set to ON, produces gamma curve close to the picture characteristics of movies.	OFF ON	OFF
COLOR MATRIX	Used to set the color matrix. When set to ON, color reproduction becomes good. However, noise will increase. 5 types of color matrix functions are provided. OFF : The function is OFF STD : Standard colour matrix WARM : Colour adjustment with red tinge EXTRA 1 to 3 : To set a color matrix other than those described above. Select the desired option. Note: When CINE MODE is ON, "FIX" is displayed and setting is not possible.	OFF STD WARM EXTRA1 EXTRA2 EXTRA3	STD
GAMMA	Compensates for the gamma curve that determines the reproducibility of black color. ● To enhance the black color reproducibility. However, halftones will be lost for white section Increase the number ● When reproducibility of the black color is not so important Decrease the number Note: When CINE MODE is ON, "FIX" is displayed and setting is not possible.	MAX (2) 1 to NORMAL (0) to -7 MIN (-8) OFF	NORMAL
FLARE <R>	For correcting the black level of Rch when the flare phenomenon in which light entering the lens is diffused and results in reflection that colors the black portions of the image occurs. To weaken tinge of red ... Increase the number To strengthen tinge of red ... Decrease the number Note: When LOLUX is ON, "FIX" is displayed and setting is not possible.	MAX +9 to NORMAL to -9 MIN	NORMAL
FLARE 	For correcting the black level of Bch when the flare phenomenon in which light entering the lens is diffused and results in reflection that colors the black portions of the image occurs. To weaken tinge of blue ... Increase the number To strengthen tinge of blue ... Decrease the number Note: When LOLUX is ON, "FIX" is displayed and setting is not possible.		
SKIN COLOR ADJUST	Pressing the SHUTTER dial once when the cursor is at this position switches the screen to display the SKIN COLOR ADJUST screen.	—	—
PAGE BACK	The CAMERA PROCESS menu screen returns when the SHUTTER dial is pressed with the cursor at this position.	—	—

11-8 SKIN COLOR ADJUST Screen

Item	Function	Variation Range	Initial Setting
SKIN COLOR DET.	Sets whether it is possible to change the color used by the Skin Tone Detail function. EXECUTE: Choose this setting to allow detection of the color used by the Skin Tone Detail function. STOP : Choose this setting to stop detection of the color used by the Skin Tone Detail function. ☞ See "Using the Skin Tone Detail Function" on page 86.	STOP EXECUTE	STOP
SKIN COLOR RANGE	The setting of this item can only be changed when the SKIN COLOR DET. item is set to EXECUTE. This setting is for adjusting the skin color range where Skin Tone Detail functions. (When this item is selected, the area where the Skin Tone Detail function is applicable is indicated by zebra patterns on the screen.) While viewing the zebra pattern range, perform the adjustment. Increasing the range Increase the number Decreasing the range Decrease the number	WIDE +11 to NORMAL to -11 NARROW	NORMAL
PAGE BACK	The ADVANCED PROCESS menu screen returns when the SHUTTER dial is pressed with the cursor at this position.	—	—

11. MENU SCREENS

11-9 AUDIO/VIDEO Menu Screen

Item	Function	Variation Range	Initial Setting
TEST TONE	Sets whether or not the audio reference signal (1kHz, -20dBFS or -12dBFS) should be output while the color bar is output. OFF: Audio reference signal is not output. ON: Audio reference signal is output.	OFF ON	OFF
AUDIO MODE	Selects the sampling frequency for audio recording (both CH-1 and CH-2) 32K : Recording is performed with 12-bit, 32 kHz sampling frequency 48K : Recording is performed with 16-bit, 48 kHz sampling frequency * The DV format offers recording tracks for up to 4 channel when using 12-bit, 32 kHz sampling. The GY-DV5000 records two of these tracks. The GY-DV5000 does not allow after-recording.	32K 48K	48K
A.OUT AT SEARCH	Selects whether or not audio should be output during search. OFF : Audio is not output ON : Audio is output	OFF ON	ON
CH1 FRONT VR	Used to select whether or not the front section audio level control should be operative. The front section audio level control only affects the audio signal recorded on CH1. DISABLE: Use of the front section audio level control is disabled. ENABLE: Use of the front section audio level control is enabled. * The operation of the CH-1 audio level control on the side section is unaffected by this setting.	DISABLE ENABLE	ENABLE
WIND CUT	To select whether or not the low frequencies of the audio signal from the audio input connectors are cut. Set to ON to reduce the wind noise of the microphone. OFF : Low frequencies are not cut. FRONT : Only the low frequencies of the audio signal input to the FRONT AUDIO IN connector are cut. REAR : Only the low frequencies of the audio signal input to the REAR AUDIO IN connector are cut. BOTH : The low frequencies are cut for both the FRONT and REAR AUDIO IN connectors.	OFF FRONT REAR BOTH	OFF
AUDIO REF. LEVEL	Sets the reference audio level of the tape (both CH-1 and CH-2). -20dB : Records with -20 dB as the reference audio level. -12dB : Records with -12 dB as the reference audio level. Use this setting when playing back the tape using DV equipment for general consumer use. * Use the same setting for playback as for recording. * This setting is unrelated to the audio level of the IEEE 1394 signal.	-20dB -12dB	-20dB
AUDIO SELECT	Used to select which channels to reproduce when playing back a tape with sound recorded on 4 channels. (Can only be set in the VTR mode.) CH1/2 : To reproduce the sound recorded on CH-1 and CH-2. The GY-DV5000 records audio on the CH-1 and CH-2 channels during shooting. MIX : To simultaneously reproduce the sound of all four channels. CH3/4 : To reproduce the sound of the CH-3 and CH-4 channels. MEMO: The GY-DV5000 does not allow after-recording on the CH-3 and CH-4 channels.	CH1/2 MIX CH3/4	CH1/2
AUDIO MONITOR	Selects whether stereo sound or mixed sound is output from the PHONES jack when the MONITOR SELECT switch is set to MIX. STEREO : Stereo sound (CH-1 audio is output from L, CH-2 audio is output from R) * Only audio of CH-1 is output from the monitoring loudspeaker. MIX : Mixed sound (The mixed CH-1 and CH-2 audio is output from L and R)	STEREO MIX	MIX
SET UP	Selects whether the camera image or VTR playback image should be provided with the setup signal. * Setup signal can be selected even for IEEE1394 signal input. 0.0% : Setup signal is not attached to the recording/playback signal. 7.5% : Setup signal is attached to the recording/playback signal.	0.0% 7.5%	7.5%
PAGE BACK	The TOP MENU screen returns when the SHUTTER dial is pressed while the cursor is at this position.	—	—

11. MENU SCREENS

11-10 LCD/VF Menu Screen

The LCD/VF menu screen consists of two screens. (1/2 screen, 2/2 screen)

■ LCD/VF (1/2) Menu Screen

Settings can be made on the LCD/VF (1/2) menu screen only in the Camera mode.

Item	Function	Variation Range	Initial Setting
ZEBRA	Switches the luminance level of the subject sections where the zebra pattern is displayed. 70-80% : Zebra pattern is displayed in sections with luminance levels between 70% and 80%. 85-95% : Zebra pattern is displayed in sections with luminance levels between 85% and 90%. OVER 95% : Zebra pattern is displayed in sections with luminance levels over 95%. OVER 100% : Zebra pattern is displayed in sections with luminance levels over 100%.	70-80% 85-95% OVER 95% OVER 100%	70-80%
F.NO/ IRIS IND.	Selects whether or not the F-number of the lens iris/iris level mark is displayed in the status display on the LCD monitor or in the viewfinder. (Status 1 screen) OFF : F-number and iris level mark is not displayed. F.NO : F-number is displayed. F.NO+IND. : F-number and iris level mark is displayed.	OFF F.NO F.NO+IND.	OFF
FILTER	Selects whether or not the FILTER position of the unit is displayed in the status display on the LCD monitor or in the viewfinder. (Status 1 screen) OFF : FILTER position is not displayed. ON : FILTER position is displayed.	OFF ON	OFF
SAFETY ZONE	Selects whether or not the safety zone is shown on the LCD monitor or in the viewfinder together with the form of the safety zone indication. OFF : Not displayed NORMAL : 4:3 zone is displayed. 16:9 : 16:9 zone is displayed.	OFF NORMAL 16:9	OFF
CENTER MARK	Sets whether or not a center mark is displayed when the safety zone is displayed. ON : Center mark is displayed. OFF : Center mark is not displayed. CAUTION: When the SAFETY ZONE item is set to OFF, " - - " is indicated and this item cannot be selected.	ON OFF	ON
NEXT PAGE	To display the LCD/VF (2/2) menu screen, align the cursor with this item and then press the SHUTTER dial.	—	—
PAGE BACK	The TOP MENU screen returns when the SHUTTER dial is pressed while the cursor is at this position.	—	—

11. MENU SCREENS

11-10 LCD/VF Menu Screen (Cont'd)

■ LCD/VF (2/2) Menu Screen

Item	Function	Variation Range	Initial Setting
TAPE REMAIN	Selects whether or not the remaining tape time (minutes) is shown in the status display on the LCD monitor or in the viewfinder. (Camera mode: Status 1 screen, VTR mode: Status screen) OFF : Not displayed. ON : Displayed.	OFF ON	ON
TC/UB	Selects whether or not the time code or user's bits data should be shown in the status display on the LCD monitor or in the viewfinder. (Camera mode: Status 1 screen, VTR mode: Status screen) OFF : Not displayed. ON : Displayed. * Whether the time code or user's bits data is shown is selected with the COUNTER switch.	OFF ON	OFF
AUDIO	Selects whether the audio level meters should be shown in the status display on the LCD screen and the viewfinder screen. (Camera mode: Status 1 screen, VTR mode: Status screen) OFF : Not displayed. ON : Displayed.	OFF ON	OFF
LCD COLOR	Adjusts the color saturation of the LCD monitor.	MAX (5) 4 ┆ NORMAL ┆ -4 MIN (-5)	NORMAL
LCD PEAKING	Adjusts the contour of the LCD monitor.	MAX (5) 4 ┆ NORMAL ┆ -4 MIN (-5)	NORMAL
PAGE BACK	To return to the LCD/VF (1/2) menu screen, align the cursor with this position and then press the SHUTTER dial.	—	—

11. MENU SCREENS

11-11 TC/UB/CLOCK Menu Screen

Time codes and user's bits can be set on this screen. Date and time is set on the screen that can be reached from this screen.

Item	Function	Variation Range	Initial Setting
TC PRESET	To preset the time code, align the cursor with this position and then press the SHUTTER dial. EXECUTE: The set time code is confirmed. CANCEL: The set time code is cancelled.	EXECUTE CANCEL	EXECUTE
TC CLEAR	To reset the time code setting, set to EXECUTE and then press the SHUTTER dial. CANCEL: Setting is not reset. EXECUTE: Setting is reset	CANCEL EXECUTE	CANCEL
UB PRESET	To preset the user's bit data, align the cursor with this position and then press the SHUTTER dial. EXECUTE: The set user's bit data are confirmed. CANCEL: The set user's bit data are cancelled.	EXECUTE CANCEL	EXECUTE
UB CLEAR	To reset the user's bit data setting, set to EXECUTE and then press the SHUTTER dial. CANCEL: Setting is not reset. EXECUTE: Setting is reset	EXECUTE CANCEL	CANCEL
<p>MEMO: For presetting of the time code and the user's bit data, see page 63.</p>			
DROP/ NON DROP	To select the time code generator's framing mode as either drop or non-drop mode. DROP: The internal time code generator runs in drop mode. Choose this setting when emphasizing the recorded time. NON DROP: The internal time code generator runs in non drop mode. Choose this setting when emphasizing the frame number.	DROP NON DROP	DROP
TIME/DATE	To make settings related to the date and time, align the cursor with this position and then press the SHUTTER dial. ☞ See "TIME/DATE Menu Screen" on page 76.	—	—
PAGE BACK	The TOP MENU returns when the SHUTTER dial is pressed while the cursor is at this position.	—	—

11. MENU SCREENS

11-12 TIME/DATE Menu Screen

Item	Function	Variation Range	Initial Setting
DISPLAY	Sets whether the date and time are shown in the status display on the LCD monitor or in the viewfinder. OFF: Not displayed. ON : Displayed. When a tape with time and date not recorded is played back, there will be no display of time and date even when this item is set to ON.	OFF ON	OFF
DISPLAY MODE	In the Camera mode, the date and time are displayed in accordance with the following settings. In the VTR mode, the date and time are always displayed. BARS+CAM : Date and time are always displayed. BARS: Date and time are displayed when the OUTPUT switch on the side section is set to BARS. CAM: Date and time are displayed when the OUTPUT switch on the side section is set to CAM. When the DISPLAY item is set to OFF, " - - " is indicated and this item cannot be selected.	BARS+CAM BARS CAM	BARS+CAM
DATE REC	Selects whether date and time are to be recorded on the tape as video data or not, as well as the video mode in case of recording. Recording is done according to the set position of the OUTPUT switch at the side panel. OFF : Date and time data are not recorded. BARS : Date and time data are recorded when color bars are output. BARS+CAM: Date and time data are recorded when color bars and camera image are output. When the DISPLAY item is set to OFF, " - - " is indicated and this item cannot be selected. With setting to BARS or BARS+CAM, the screen size is fixed to 4:3.	OFF BARS BARS+CAM	OFF
DISPLAY STYLE	Selects the style for the date and time display. DATE+TIME: Date and time are displayed. DATE: Date only is displayed. TIME: Time only is displayed. When the DISPLAY item is set to OFF, " - - " is indicated and this item cannot be selected.	DATE+TIME DATE TIME	DATE+TIME
DATE STYLE	Selects the style for the date display. YY/MM/DD: Displayed in the format of year/month/date. MM/DD/YY: Displayed in the format of month/date/year. DD/MM/YY: Displayed in the format of date/month/year. When the DISPLAY item is set to OFF, " - - " is indicated and this item cannot be selected.	YY/MM/DD MM/DD/YY DD/MM/YY	MM/DD/YY
TIME STYLE	Selects the style for the time display. 24 HOUR: Displays the time using the 24-hour system. 12 HOUR: Displays the time using the 12-hour system. When the DISPLAY item is set to OFF, " - - " is indicated and this item cannot be selected.	24 HOUR 12 HOUR	24 HOUR
SEC DISPLAY	Selects whether to display the seconds in the time display. OFF: Seconds are not displayed. ON : Seconds are displayed. When the DISPLAY item is set to OFF, " - - " is indicated and this item cannot be selected.	OFF ON	ON
CLOCK ADJUST	To adjust the date and time, align the cursor with this position and then press the SHUTTER dial. The date and time are set on the CLOCK ADJUST screen. For the setting method, see "Setting, Displaying and Recording the Date and Time" on page 41.	—	—
PAGE BACK	The TC/UB/CLOCK menu returns when the SHUTTER dial is pressed while the cursor is at this position.	—	—

11. MENU SCREENS

11-13 OTHERS Menu Screen

The OTHERS menu screen consists of two screens (1/2 screen, 2/2 screen)

OTHERS (1/2) Menu Screen

Item	Function	Variation Range	Initial Setting
OUTPUT CHAR.	Selects whether characters should be displayed on the screen of a monitor connected to MONITOR OUT connector or Y/C OUT connector. OFF : No on-screen-display ON : On-screen-display	OFF ON	OFF
NET REMOTE	Set when the optional Network Pack KA-DV5000 is attached. Selects whether the GY-DV5000 should be controlled by an external signal input via the network pack. OFF : Not controlled. ON : Controlled. (Operation from the main unit is disabled.)	OFF ON	OFF
DV REC TRIGGER	Selects whether or not the VTR trigger command should be output through the DV connector. Set to ON when the GY-DV5000's DV signal should be recorded on another component for backup. OFF: VTR trigger command is not output. ON : VTR trigger command is output. * Set this item to OFF, when the Backup Recording function of BR-DV600A or BR-DV3000 is used.	OFF ON	ON
LONG PAUSE TIME	Selects the time (minutes) before the tape protect mode (drum head rotation stopped) is engaged when the record-standby condition continues. 3MIN : 3 minutes 30MIN: 30 minutes * When used in a cold environment or when the stopped or STILL status continues, the setting will be 3 minutes regardless of the setting on the menu.	3MIN 30MIN	30MIN
REM FF/REW MODE	Selects the operation when the FF or REW command is received when the GY-DV5000 is remote controlled using a non-linear editing controller. FF/REW : Fast forward or rewinding is executed. Normally, this setting is used. SEARCH : FWD search or REV search is executed. Use this setting when detection of the beginning of programs (cue-up) works less than satisfactorily when this item is set to FF/REW.	FF/REW SEARCH	FF/REW
STEP SLOW MODE	Selects the amount of frames advanced in the STILL mode. (Frame advance is only available with an external remote control signal.) FIELD : Field-by-field frame advance. FRAME : Frame-by-frame frame advance.	FIELD FRAME	FRAME
NEXT PAGE	To display the OTHERS (2/2) menu screen, align the cursor with this item and then press the SHUTTER dial.	—	—
PAGE BACK	The TOP MENU screen returns when the SHUTTER dial is pressed while the cursor is at this position.	—	—

11. MENU SCREENS

11-13 OTHERS Menu Screen (Cont'd)

OTHERS (2/2) Menu Screen

Item	Function	Variation Range	Initial Setting
ALARM VR LEVEL	Selects whether or not alarm sound is emitted and the volume of the alarm sound. The alarm sound is output through the monitoring loudspeaker and the PHONES jack. OFF : Sound is not output. LOW : Alarm sound is soft. MIDDLE : Alarm sound is normal. HIGH : Alarm sound is loud.	OFF LOW MIDDLE HIGH	HIGH
BATTERY TYPE	To be set in accordance with the used battery back type. 12V : Choose this setting when using 12 V battery (12VDC Flat shape type). 13.2V : Choose this setting when using 13.2 V battery (Anton-Bauer Trimpack 13, Propack 13, Magnum 13, Compac 13). 14.4V : Choose this setting when using 14.4 V battery (Anton-Bauer Trimpack 14, Propack 14, Magnum 14, Compac 14). <ul style="list-style-type: none"> ● If this setting is wrong or neglected, the unit's display of remaining battery power and generation of battery alarm will not work correctly. ● This setting is valid when a battery pack is used. It is invalid when a DC power supply is used. 	12V 13.2V 14.4V	12V
FRONT TALLY	Selects the lighting method of the TALLY lamp in the viewfinder during recording. This setting is valid when the viewfinder's TALLY switch is set to ON. BLINK : The lamp blinks from when the VTR trigger is pressed and until recording starts. The lamp lights steadily during recording. ON : The lamp lights only during recording.	BLINK ON	BLINK
BACK TALLY	Selects the lighting method of the TALLY lamp on the rear section during recording. OFF : The lamp is always off. BLINK : The lamp blinks from when the VTR trigger is pressed and until recording starts. The lamp lights steadily during recording. ON : The lamp lights only during recording.	OFF BLINK ON	BLINK
PAGE BACK	The OTHERS (1/2) menu screen returns when the SHUTTER dial is pressed while the cursor is at this position.	—	—
DRUM HOUR	Displays the accumulated time that the drum has been in operation. To be used as a yardstick for periodical maintenance. The cursor (▶) cannot be moved to this item.	—	—

12. FEATURES OF THE CAMERA SECTION

12-1 Full-Time Auto White Balance (FAW)

```

--- CAMERA OPERATION ---
SHUTTER          STEP
▷FAW             A
GAIN L           0dB
GAIN M           6dB
GAIN H           9dB
LOLUX GAIN       30dB
SMOOTH TRANS     OFF
SPOT L / BACK L MIDDLE
ASPECT RATIO     4 : 3
PAGE BACK
    
```

The FAW function adjusts the white balance value automatically as the lighting condition changes.

This mode is convenient when you have no time to adjust the white balance or when the camera is moved frequently in and out of places under different lighting conditions.

Setting procedure

The FAW function can be activated with the FAW item on the CAMERA OPERATION menu.
This item allows allocation of the FAW function to one of the WHT.BAL switch positions, A, B or PRST.
* See "CAMERA OPERATION Menu Screen" on page 69.

CAUTION:

The FAW (Full-time Auto White balance) function cannot provide optimum white balance with a subject outside the FAW adjustment range, for example when it contains only a single color or not enough white color.

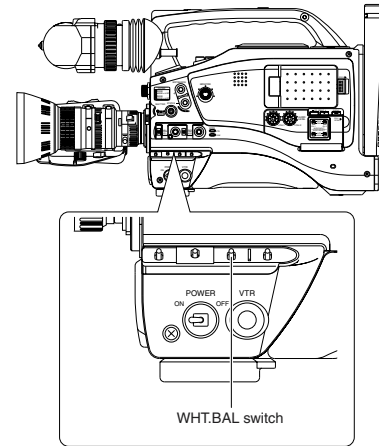

12. FEATURES OF THE CAMERA SECTION

12-2 IRIS (Brightness) Adjustment

ADJUSTMENT OF LENS IRIS

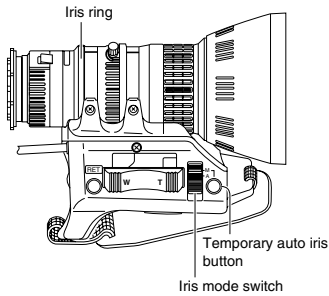

The lens iris can be adjusted using any of the following three methods.

- Automatic adjustment**
 Set the iris mode switch to "A" (Auto). The iris is adjusted automatically according to the brightness of the object.
- Manual adjustment**
 Set the iris mode switch to "M" (Manual). The iris can be adjusted manually by rotating the iris ring.
- Temporary auto iris adjustment**
 During manual iris adjustment, the auto iris adjustment mode is activated only while this temporary auto iris button is held depressed.

Changing the auto iris adjustment setup

- Under special lighting conditions such as backlight, it is often appropriate to change the value set by the auto iris adjustment. This can be done by the following method.
- Setting the AUTO IRIS LEVEL switch of the camera
- ☞ See "SWITCH FUNCTIONS" on page 84.

ZEBRA PATTERN DISPLAY DURING MANUAL ADJUSTMENT

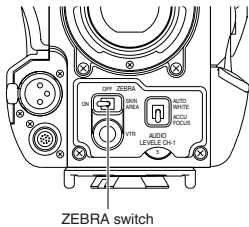

By setting the switch to **ON**, oblique stripes (zebra pattern) can be imposed on the viewfinder or LCD areas having luminance levels in accordance with the menu settings made for the video signal. The zebra pattern can be used as a reference for manual iris adjustment.

- The initial setting is 70 to 80%. However, using the ZEBRA setting on the LCD/VF (1/2) menu screen, zebra patterns can be displayed in the sections with a luminance level of 85 to 95%, over 95% and over 100%.
- ☞ See "LCD/VF Menu Screen" on page 73.

12. FEATURES OF THE CAMERA SECTION

12-3 Adjusting the Shutter Speed

Adjust the shutter speed to obtain special effects or when shooting scenes with slow-moving subjects.

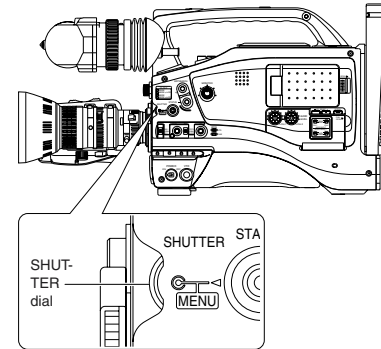

Setting

- Set the **SHUTTER** item on the **CAMERA OPERATION** menu screen.

STEP : The shutter speed is changed in fixed steps.
VARIABLE: The shutter speed is changed with variable scan. This setting is used for shooting the screen image on a computer monitor, etc.

Operation

- Rotate the SHUTTER dial while the normal screen is shown. (when menu screens are not displayed). (If "SHUTTER OFF" is displayed, press the SHUTTER dial.)
 - The current shutter speed is shown on the LCD monitor or in the viewfinder for approximately 3 seconds.
- Rotate the SHUTTER dial while the shutter speed is shown. Rotating the dial downward makes the shutter slower, and rotating it upward makes it faster.

- Stop rotating the SHUTTER dial when the desired shutter speed is indicated. The set shutter speed value is displayed for about 3 seconds on the LCD monitor or in the viewfinder.

Setting range

STEP: 1/7.5, 1/15, 1/30, 1/60, 1/100, 1/250, 1/500, 1/1000, 1/2000, 1/4000, 1/10000

VARIABLE: 1/60.1 Hz to 1/2084.6 Hz

- To return the shutter speed to the initial setting, press the **SHUTTER** dial.

Initial setting: OFF ("SHUTTER OFF" is indicated on the screen.)

CAMERA OPERATION menu screen

```

-- CAMERA OPERATION --
>SHUTTER          STEP
FAW              NONE
GAIN L           0dB
GAIN M           6dB
GAIN H           9dB
L D L U X G A I N 30dB
SMOOTH TRANS     OFF
SPOT L / BACK L MIDDLE
ASPECT RATIO     4 : 3
PAGE BACK
    
```

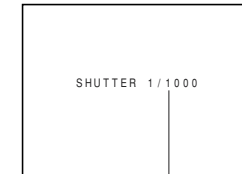

Shutter speed indication

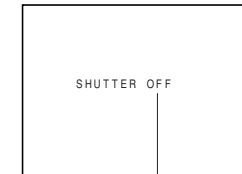

Indication of initial shutter speed value

12. FEATURES OF THE CAMERA SECTION

12-4 Shooting the Screen Image on a Computer Monitor

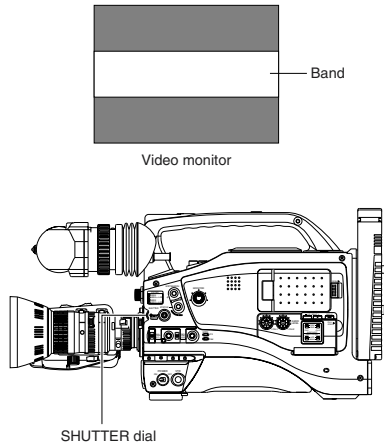

```

--- CAMERA OPERATION ---
>SHUTTER      VARIABLE
FAW           A
GAIN L        0dB
GAIN M        6dB
GAIN H        9dB
LOLUX GAIN    30dB
SMOOTH TRANS  OFF
SPOT L/BACK L MIDDLE
ASPECT RATIO  4:3
PAGE BACK
    
```

CAMERA OPERATION menu screen

■ Outline

The following operation allows the alignment of the shutter speed of the camera with the variable scanning rate of a computer monitor or display.

When a computer monitor screen or display is shot with the camera, a bright horizontal line indicating excessive exposure is displayed in cases when the scanning rate of the monitor is faster than the shutter speed of the camera. A dark horizontal line indicating insufficient exposure is displayed in cases when the monitor's scanning rate is slower than the camera's shutter speed.

The scanning frequency of a monitor varies due to various reasons during the computer operation. Adjust the scanning rate to obtain a stable image while observing the image in the viewfinder or LCD monitor.

■ Variable Scan [V.SCAN]

• Basic operation

Set the SHUTTER item on the CAMERA OPERATION menu screen to VARIABLE. Then rotate the SHUTTER dial upward or downward to change the shutter speed. (The speed is displayed in the viewfinder or LCD monitor.)

• Compatible frequencies

The variable scan function is compatible with scanning frequencies in the following range.
60.1Hz to 2084.6 Hz

CAUTION:

This function is not compatible with slow-speed computer monitors with a vertical scanning speed of 50 Hz.

12. FEATURES OF THE CAMERA SECTION

12-5 Gain (Sensitivity) Adjustment

The gain should be switched when the brightness is insufficient due to poor lighting conditions.

GAIN SWITCHING

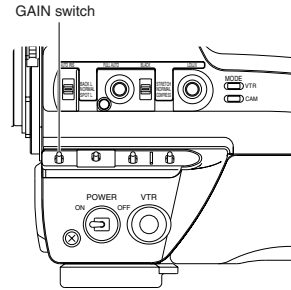

This switch allows the gain to be boosted when the illumination of the subject is insufficient.

Switch Position	Factory-Set Gain
L	0dB
M	9dB
H	18dB

When the GAIN switch is switched, the newly set gain is displayed for about 3 seconds on the Status (0, 1, 3) screen in the viewfinder or LCD monitor. Set it to L (0 dB) in normal use.

■ The gain set for each of the switch positions can be changed with "GAIN" on the CAMERA OPERATION menu screen. It is also possible to use the ALC function that varies the gain automatically.

A setting at -3dB corresponds to a decreased sensitivity equivalent to the brightness of a 1/2 filter.

☞ See page 69 for details.

■ The gain transition can be made smoother by selecting "SMOOTH TRANS" on the CAMERA OPERATION menu screen.

☞ See page 69.

However, note that the SMOOTH TRANS function is not available if gain is set to ALC.

CAUTION:

When gain is set to "ALC", gain is boosted automatically as the illumination becomes darker. However, noise will increase a little because the screen becomes brighter as the ALC (Auto Level Control) function boosts the gain more than in the case of manual adjustment.

GAIN BOOST UNDER LOLUX CONDITION

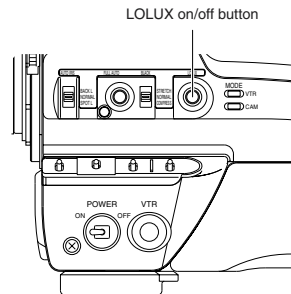

The LOLUX button is used when the illumination is still insufficient after compensating with the GAIN switch.

Pressing the LOLUX button again will enter the LOLUX mode. The gain up value during the LOLUX mode is set in LOLUX GAIN of the CAMERA OPERATION menu.

"LOLUX ON" is displayed for about 3 seconds on the Status (0, 1, 3) mode screen in the viewfinder or LCD monitor.

Pressing the button again cancels the LOLUX mode.

"LOLUX OFF" is displayed for about 3 seconds.

■ When the LOLUX function is in use, the image definition on the screen will degrade to increase residual images, but this is not a malfunction.

Relationship between gain, iris and shutter

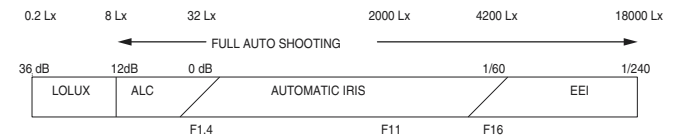

12. FEATURES OF THE CAMERA SECTION

12-6 Switch Setup According to Illumination and Subject

Various switch settings are performed to accommodate the conditions of the illumination and the subject when shooting.

SWITCH FUNCTIONS

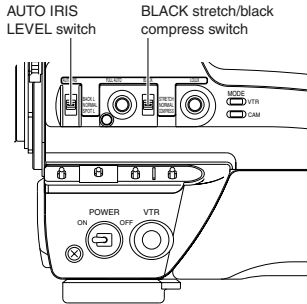

① AUTO IRIS LEVEL switch

This switch allows the reference value for the auto iris adjustment to be changed according to the lighting condition.
BACK L : When the subject is in backlit conditions.
 Opens the iris wider than the standard setting.
NORMAL: Normal lighting condition.
SPOT L : When the subject is under a spotlight.
 Closes the iris narrower than the standard setting.

■ The level of auto iris can be set in SPOT L/BACK L on the CAMERA OPERATION menu screen when the AUTO IRIS switch is set to BACK L or SPOT L. See page 69.

② BLACK stretch/black compress switch

This switch makes the image easier to see by varying the black gain.
BLACK STRETCH : Boosts the gain of black areas to improve the reproducibility of black.
NORMAL : Normal black gain.
BLACK COMPRESS : Attenuates the gain of black areas to make the image sharper.

FULL AUTO SHOOTING (FAS) FUNCTION

FULL AUTO indicator FULL AUTO/shooting button

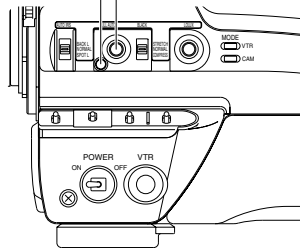

The FAS function provides a wide range of compatibility with shooting conditions that varies as you move between indoors and outdoors or between bright and dark locations. It eliminates the need to change the switch and filter positions every time you move.

The FAS function provides an integrated control of the ALC (Automatic Level Control), Auto iris and FAW (Full-time Auto White balance) functions.

Operation

- Simply press the FULL AUTO button to enter the FAS mode, in which the FULL AUTO indicator lights and "FAS" is displayed to the right in the viewfinder or LCD monitor.
- Pressing the FULL AUTO button again cancels the FAS mode and turns the FULL AUTO indicator off.

■ Automatic Setting Contents

- If you have been displaying the color bars, the screen is switched automatically to the camera image.
- The auto iris adjustment mode is entered even if the iris mode switch of the lens is set to manual.
- The GAIN switch and WHT.BAL switch settings are defeated in the FAS mode.
- The LOLUX button setting is active even in the FAS mode. However, the ALC and EEI are defeated in the LOLUX mode, in which only the auto iris adjustment and FAW are used.
- All of the previous setting contents are recalled when the FAS mode is cancelled.
- The SMOOTH TRANS function is defeated during switch to the FAS function.

CAUTION:

- When the power is turned on while the camera is in the FAS mode, it takes about 10 seconds before the automatic adjustment of FAS is completed.

12. FEATURES OF THE CAMERA SECTION

12-7 How to Use Skin Detail

The contour emphasis in the skin color areas of the video signal can be controlled and made to appear gentle and smooth.

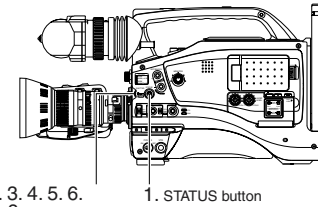

- STATUS button
- SHUTTER dial

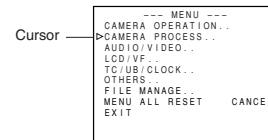
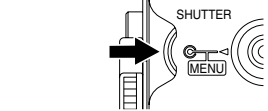

TOP MENU screen

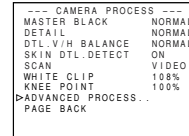

CAMERA PROCESS menu screen

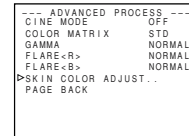

ADVANCED PROCESS screen

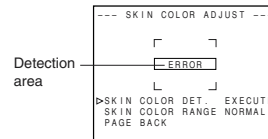

SKIN COLOR ADJUST screen



SKIN COLOR ADJUST screen

■ Setting the Color and Range of the Skin Detail Function

- Press the STATUS button for about 1 second to display the TOP MENU screen.
- Turn the SHUTTER dial downward to align the cursor (▶) with the CAMERA PROCESS item. Then press the SHUTTER dial in the direction of the arrow to display the CAMERA PROCESS menu screen.
- Turn the SHUTTER dial downward to align the cursor (▶) with the ADVANCED PROCESS item. Then press the SHUTTER dial in the direction of the arrow to display the ADVANCED PROCESS menu screen.
- Turn the SHUTTER dial downward to align the cursor (▶) with the SKIN COLOR ADJUST item. Then press the SHUTTER dial in the direction of the arrow to display the SKIN COLOR ADJUST screen.
 - The frame shown on the screen indicates the detection area of the skin detail function.
- When the cursor (▶) is aligned with the SKIN COLOR DET. item, the SHUTTER dial is pressed in the direction of the arrow and EXECUTE selected, the skin color detection mode is activated.
 - The color is recognized as a color that the skin detail function works with.
 - The areas recognized by the skin detail function appear with superimposed zebra patterns.
 - If the color is not recognized as a color that the skin detail function works with, "ERROR" is displayed on the screen.
- If you want to change the color range recognized by the skin detail function, perform the following operations. Set the SKIN COLOR DET. item to EXECUTE.
 - Turn the SHUTTER dial to align the cursor (▶) with SKIN COLOR RANGE, and then press the SHUTTER dial in the direction of the arrow.
 - The area with the setting value starts blinking, and the value can now be changed.
 - Turn the SHUTTER dial up or down to widen or narrow the color range.
 - Adjust the range while observing the zebra patterns.
 - To decide the color range, press the SHUTTER dial in the direction of the arrow.
 - The setting value stops blinking but remains lit.
- To stop the SKIN COLOR ADJUST operation, align the cursor (▶) with PAGE BACK and press the SHUTTER dial in the direction of the arrow.

12. FEATURES OF THE CAMERA SECTION

12-7 How to Use Skin Detail (Cont'd)

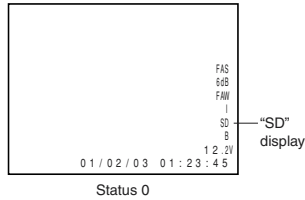

■ Using the Skin Detail Function

To use the skin detail function set on the SKIN COLOR ADJUST screen, select "ON" for the SKIN DTL DETECT item on the CAMERA PROCESS menu screen.

While the Skin Detail function operates, the "SD" indicator is displayed on the Status 0 and Status 1 screen in the viewfinder or LCD monitor.

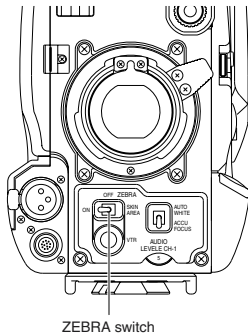

■ Confirming the color tone area adjusted with the Skin Detail function

When the ZEBRA switch on the front section is pressed to the "SKIN AREA" side, zebra patterns are indicated in the colour tone areas adjusted with Skin Detail and displayed in the viewfinder or on the LCD monitor.

13. OTHERS

13-1 Alarm Indications and Actions

The GY-DV5000 displays messages on the LCD monitor and in the viewfinder in the case of improper operation, notices on remaining battery power and tape and warnings in the case of abnormalities during VCR operation. Also, when remaining tape or battery power becomes small, or in the case of abnormalities during VCR operation, the TALLY lamps and viewfinder lamp will blink (or light steadily), and alarm sound will be output through the monitoring loudspeaker or the PHONES jack.

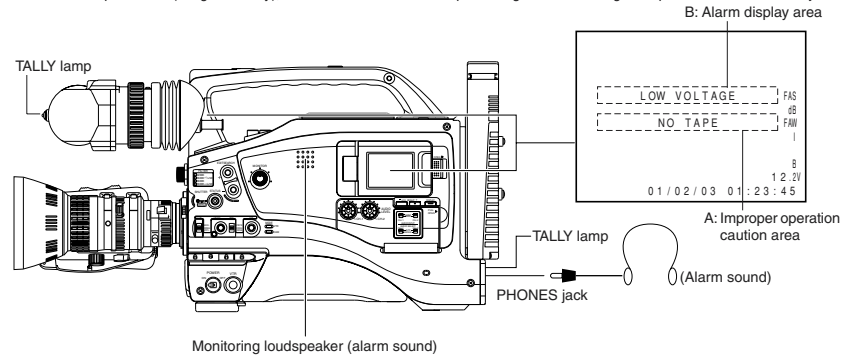

■ Screen indications on the LCD monitor and in the Viewfinder

- Improper operation caution area (Display area: A)

Indication	Condition	Remedy
INVALID TAPE!	A data tape for PC or DVCPRO videocassette use is used. The tape is forcibly ejected.	Use a standard DV videocassette or MiniDV videocassette for video use.
LP TAPE INVALID!	Attempt to play back a tape recorded in the LP mode.	The GY-DV5000 cannot play back tapes recorded in the LP mode.
NO DV SIGNAL!	DV signal is not input.	Input a DV signal.
COPY INHIBIT	Attempt to record a copy-guarded DV signal.	A copy-guarded DV signal cannot be input.
REC INHIBIT	An unrecordable videocassette (the switch on the back of the cassette is set to "SAVE") is loaded.	Set the switch on the back of the cassette to "REC".
NO TAPE	No videocassette is loaded.	Insert a videocassette.

- Alarm area (Display area: B)

Indication	Condition	Remedy
LOW VOLTAGE	Remaining battery power is low.	Prepare a charged battery or replace the battery immediately.
TAPE NEAR END	The remaining tape is 3 minutes or less. (Only displayed in the shooting mode.)	To continue the recording, prepare a new tape or replace with a new tape immediately.
HEAD CLEANING REQUIRED!	Displayed in case of video head clogging. (Head clogging is detected and indicated during edit search in the recording mode and during playback.)	Clean the head with the special head cleaning tape. (See page 8.)
COPY GUARD!	Attempt to play back a copy-guarded tape.	A copy-guarded tape cannot be played back.
CLOSE CASSETTE COVER!	The cassette cover is open.	Close the cassette cover.
OPEN CASSETTE COVER!	The cassette cover is closed.	Open the cassette cover.

MEMO:

The GY-DV5000 is a microcomputer-controlled piece of equipment, which may malfunction due to external noise or interference. In this case, turn the power OFF, and then turn it ON again.

13. OTHERS

13. OTHERS

13-1 Alarm Indications and Actions (Cont'd)

Warning Indications for VCR Abnormalities

Should malfunctions occur during VCR operation, the unit self-diagnoses the cause and shows the diagnose together with an error code on the LCD monitor or in the viewfinder.

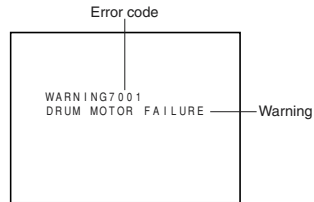

Error Code	Error Details	GY-DV5000 Operation	Remedy
0201 CONDENSATION ON DRUM	Indicates dew formation (condensation)	Operation stops. All operations are rejected.	Leave the unit with the power ON, until the indication disappears.
3200 LOADING FAILURE	Tape cannot be loaded.		Switch the power OFF and then switch it back ON. However, the tape may be damaged depending on the circumstances. Please consult the person in charge of professional video equipment at your nearest JVC-authorized service agent.
3300 UNLOADING FAILURE	Tape cannot be unloaded.		
4100 CASSETTE EJECT FAILURE	Irregularity with eject operation.		
TAPE DEFECTIVE 5605 ~ 5609	Tape is cut.	Operation stops.	Press the EJECT button to take out the cassette.
5702 TAPE END DET. ERROR	Tape end sensor error.	Operation stops. All operations are rejected.	Switch the power OFF and then switch it back ON. However, the tape may be damaged depending on the circumstances. Please consult the person in charge of professional video equipment at your nearest JVC-authorized service agent.
5802 TAPE BEGIN DET. ERROR	Tape beginning sensor error.		
7001 DRUM MOTOR FAILURE	Drum rotation error.		
7101 CAP MOTOR FAILURE	Capstan rotation error.		
7202 ~ 7203 SUPPLY REEL FAILURE	Supply reel rotation error.		
7302 ~ 7303 TAKE UP REEL FAILURE	Take up reel rotation error.		
7305 TAKE UP REEL FAILURE	Irregular tape winding when unloading.		
7401 REEL MOTOR FAILURE	Reel motor rotation error.		

TALLY lamp

Blinks when remaining battery power or tape is low. (Only in Camera mode)

Blinking Pattern	Remaining Battery/Tape
Slow blinking (once per sec.)	<ul style="list-style-type: none"> Remaining battery power is low. Remaining tape time is equivalent to less than 3 minutes.
Fast blinking (four times per sec.)	<ul style="list-style-type: none"> Tape has run out. Irregularity has occurred in the VCR.

Viewfinder Warning Lamps

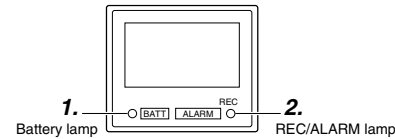

1. BATTERY lamp

This red lamp lights red under the following circumstances.
Lights red : When the battery voltage becomes too low for the camera to operate.

2. REC/ALARM lamp

This lamp lights or blinks green under the following conditions.

- Lights Green :
- While recording
- Blinks Green :
- During the interval where the unit switches from record-standby to record mode.
 - Immediately before the tape runs out or has run out.
 - If the VCR malfunctions.

Alarm Sound

When remaining battery power becomes low, a warning sound is output from the monitoring loudspeaker and the PHONES jack. (In Camera mode only)
When an irregularity occurs in the VCR, a warning sound is also output.

Whether or not alarm sound should be output and the volume level are selected with the ALARM VR LEVEL item on the OTHERS (2/2) menu screen.

Depending on the alarm conditions, the warning indicators on the LCD monitor/viewfinder screen, the TALLY lamp, the viewfinder lamp, and alarm sounds appear as shown in the following table.

Alarm Indications on LCD Monitor/Viewfinder Screen	TALLY Lamp	Lamp Viewfinder Lamp		Alarm Sound	Condition
		Alarm	BATT		
VTR alarm indication (Example) 0701 DRUM MOTOR FAILURE			—		Dew formation (condensation) or error has occurred in the VCR.
HEAD CLEANING REQUIRED!			—		Video head clogging [Detected and displayed during playback and edit search in the Camera mode.]
TAPE NEAR END			—		About 3 min. before tape end (displayed during recording).
			—		Tape end (displayed during recording).
LOW VOLTAGE and Voltage indication on Status screen blinks					Remaining battery power is low.

Display symbols :Blinking once per second. :Blinking four times per second.
 :Sound interrupted once per second. :Continuous sound.

13. OTHERS

13. OTHERS

13-2 Troubleshooting

Symptoms	Remedy
Power cannot be switched ON.	<ul style="list-style-type: none"> Is power supply connected correctly? Is battery pack recharged? Was the power turned ON immediately after being turned OFF? Wait at least 5 seconds before turning the power ON again once it has been turned OFF.
Recording is not possible.	<ul style="list-style-type: none"> Is the switch on cassette set to "REC"? If it is set to "SAVE", set it to "REC". The Camera mode has not been selected. (The CAM indicator does not light.) While the VTR indicator lights, press the MODE switch upward to turn on the CAM indicator.
Camera image does not appear on LCD monitor or in viewfinder.	<ul style="list-style-type: none"> The Camera mode has not been selected. (The CAM indicator does not light.) While the VTR indicator lights, camera image will not be output. Press the MODE switch upward to turn on the CAM indicator.
Image shown on LCD monitor or in viewfinder is dark or blurred.	<ul style="list-style-type: none"> Adjust the brightness of the LCD monitor or viewfinder screen. Is the color temperature conversion filter knob set to 5600K+ND? Is the iris closed? Is the shutter speed too fast? Is the viewfinder cable correctly connected?
Playback does not start when the play button is pressed.	<ul style="list-style-type: none"> In the Camera mode, is "STOP" indicated as the VTR operation mode indicator? When "STBY" is indicated, press the STOP button to display "STOP".
DV signal cannot be input.	<ul style="list-style-type: none"> The VTR mode has not been selected. (The VTR indicator does not light.) While the CAM indicator lights, press the MODE switch upward to turn on the VTR indicator.
Noise interferes with playback video.	<ul style="list-style-type: none"> Video head may be clogged with dirt. Clean head with the special head cleaning tape. (See "Precautions for Use of Head Cleaning Tape" on page 8.)
Sound is not output during playback.	<ul style="list-style-type: none"> Is the AUDIO SELECT item on the AUDIO/VIDEO menu screen set to CH3/4. To output the sound of the recording, set to CH1/2.
Noise appears when playing back a tape recorded on another unit.	<ul style="list-style-type: none"> When a tape recorded on another unit is played back or used for recording, this phenomenon may occur due to tracking errors.
The transient section between scenes recorded on other units and those recorded on the GY-DV5000 may appear disturbed.	
The front section's audio level control doesn't work.	<ul style="list-style-type: none"> Is the CH1 FRONT VR item on the AUDIO/VIDEO menu screen set to "DISABLE"? If so, set to "ENABLE".
The front section's audio level control doesn't change the audio level of the sound input to CH2.	<ul style="list-style-type: none"> The front section's audio level control cannot be used to change the audio level of the sound input to CH2. Use the side section's CH2 audio level control for this purpose.
Remaining battery power display is incorrect.	<ul style="list-style-type: none"> The OTHERS (2/2) menu screen's BATTERY TYPE item may not be set correctly in accordance with the type of battery in use. If the menu item setting is incorrect, set it correctly using the OTHERS (2/2) menu screen's item BATTERY TYPE.
Battery alarm is displayed and the GY-DV5000 enters the non-operating mode even when a fully charged battery is used.	<ul style="list-style-type: none"> Is the battery old?
Cassette cannot be ejected after the power is turned ON.	<ul style="list-style-type: none"> The capacity of the power supply may be insufficient. Check the power voltage.
Time code or user's bits data not displayed.	<ul style="list-style-type: none"> Is the TC/UB item on the LCD/VF menu screen set to OFF? If so, set to ON.
The date and time are not displayed or recorded.	<ul style="list-style-type: none"> Is the DISPLAY item on the TIME/DATE menu screen set to OFF? Set to ON when the data should be displayed and recorded. To record the data, set the DATE REC item as well. Is the date and time setting made? See "Setting, Displaying and Recording the Date and Time" on page 41-43.

13-3 Hour Meter Display

The GY-DV5000 can display the accumulated running time of the head drum in the HOUR METER item on the OTHERS (2/2) menu screen. Use this as a guide for periodical maintenance. See page 7.

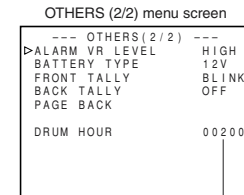
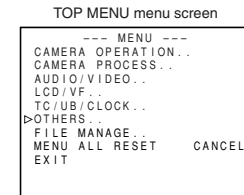
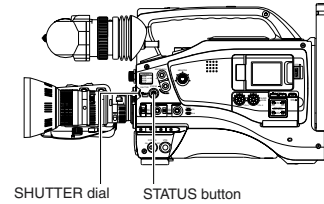

Accumulated drum running time

- Set the POWER switch to ON.
 - Press the STATUS button for 1 second or longer to display the TOP MENU screen.
 - Rotate the SHUTTER dial to select the OTHERS item, and then press the SHUTTER dial.
 - The OTHERS (1/2) menu screen appears.
 - Select the NEXT PAGE item on the OTHERS (2/2) menu screen, and then press the SHUTTER dial.
 - The OTHERS (2/2) menu screen appears.
- The accumulated drum running time is shown next to the DRUM HOUR item on the OTHERS (2/2) menu screen.
- To return to the normal screen, use either of the following methods.
 - Press the STATUS button or
 - Return to the TOP MENU screen and then select the EXIT item from the TOP MENU screen before pressing the SHUTTER dial.

13. OTHERS

13-4 Specifications

■ CAMERA SECTION

Image pickup devices	: 1/2-inch interline CCD × 3
Color separation optical system	: F1.4 3-color separation prism
Number of effective pixels	: 380,000 pixels ((H) 768 × (V) 494)
Color system	: NTSC (wide-band R-Y, B-Y encoder)
Color bars	: SMPTE color bar
Sync system	: Internal sync (built-in SSG)
Lens mount	: Bayonet system (compatible with 1/2" lens)
Optical filter	: 3200 K, 5600 K, 5600K + 1/8ND, 5600K + 1/64ND
Sensitivity	: F13, 2000 lx
Minimum illumination	: 0.2 lux (F1.4, LOLUX Max mode)
Gain	: -3, 0, 3, 6, 9, 12, 15, 18 dB, ALC, LOLUX.
Shutter speed	: 1/7.5, 1/15, 1/30, 1/60, 1/100, 1/250, 1/500, 1/1000, 1/2000, 1/4000, 1/10000
V.SCAN speed	: 60.1 Hz to 2084.6 Hz
Registration	: 0.05% or less (excluding lens distortion)
Contour correction	: Horizontal: dual-edged. Vertical: 2 H

■ VTR SECTION

Format	: DV (SP mode only)
Tape speed	: 18.812 mm/sec (DV SP recording playback) 28.218 mm/sec (DV CAM playback)
Record/Play time	: 276 minutes (With LA-DV276PRO cassette) 60 minutes (With M-DV60ME cassette)
F.F/Rewind time	: Approx. 3 minutes (With LA-DV276PRO cassette)

[VIDEO]

Recording format	: 8-bit, 13.5 MHz, 4:1:1 component recording
-------------------------	---

[AUDIO]

Recording format	: 16-bit, 48 kHz, 2-channel PCM audio/12-bit, 32 kHz 4-channel PCM audio (2 channels for recording)
-------------------------	---

Frequency response	: 20 Hz to 20 kHz (in 48 kHz mode)
Wow & flutter	: Below measurable limit

[Time Code System]

Time code signal	: Compliance with SMPTE standard
-------------------------	----------------------------------

■ INPUT/OUTPUT SIGNALS

Video signal output	: 1 V (p-p), 75 ohms (BNC) unbalanced composite output.
YC output	: Y 1 V (p-p) 75 ohms unbalance C 0.286 V (p-p) 75 ohms unbalance (4-pin)
Lens	: 12-pin connector
Audio input	: Microphone -60 dBs, 3 kohm (phantom power +48V output supported) (XLR-3) Line 4 dBs, 10 kohm balanced (XLR-3)
Audio output	: -8 dBs, low impedance, unbalanced
Earphone output	: -60 to -17 dBs, at 8-ohm load (stereo sound mini-jack)
DC input	: 12V DC (11 to 15 V DC) (XLR-4)
Auxiliary power output	: 12 V DC, max. 0.1 A (11 to 15 V DC 4-pin)
DV connector	: 4-pin

■ GENERAL

Power consumption	: 24 W (with VF-P115B, standard lens and KA-DV5000) at the time of recording
Mass	: Approx. 5.5 kg (with lens (S14 × 7.3B12U), viewfinder (VF-P115B), battery (NP-1B), videocassette (M-DV30)).
Operating temperatures	: 0 °C to 40 °C
Operating humidity	: 30 % to 80 % RH
Storage temperatures	: -20 °C to 60 °C

■ ACCESSORIES

Microphone	: × 1 (SCV2987-004)*
Tripod base	: × 1 (SCV3021-001)*
Hexagon wrench	: × 1 (LW40409-001A)*
Instruction Manual	: × 1

* Service parts number
For details, consult your JVC dealer.

Design and specifications are subject to change without notice.

13. OTHERS

OPTIONAL ACCESSORIES

Viewfinder	: VF-P115B, VF-P116
Power zoom lens	: S14 × 7.3B12U, S17 × 6.6BRM, S20 × 6.4B12U (FUJINON) YH16 × 7K12U, YH19 × 6.7K12U (CANON)
AC power adapter	: AA-P250
Microphone	: MV-P615U, MV-P618U
Microphone holder	: KA-A50U
Network Pack	: KA-DV5000U

EXTERNAL DIMENSIONS (unit: mm)

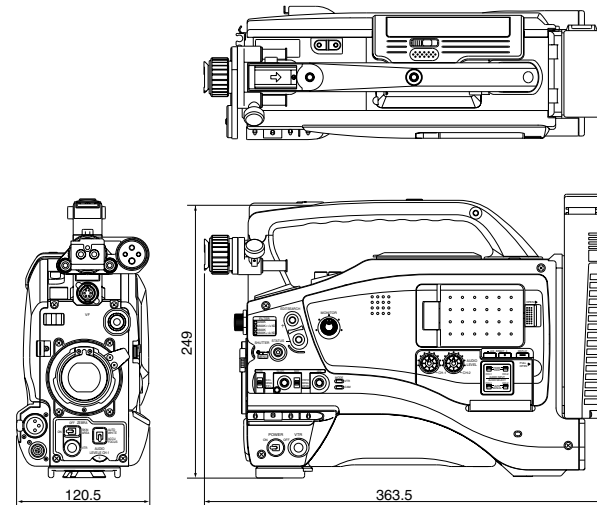

* Design and specifications are subject to change without notice.